

Owner Instructions  
Bedienerhandbuch  
Mode d'emploi  
Bedieningshandleiding voor de gebruiker



NR 1500 / NRL 1500 NRS 450 NRT 1530 NRU 1500



**Original Instructions**  
**Warning! Read instructions before using the machine.**  
**Warnhinweis**  
**Lesen Sie vor Gebrauch der Maschine das Handbuch.**  
**Attention**  
**Lisez la notice avant d'utiliser la machine.**  
**Waarschuwing**  
**Lees deze instructies voor u de machine gebruikt**



[www.numatic.com](http://www.numatic.com)

1

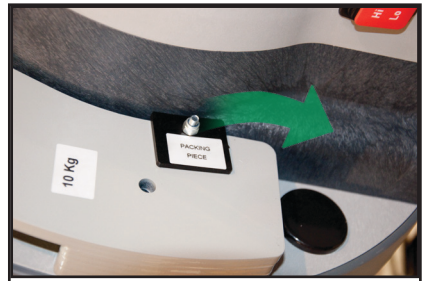
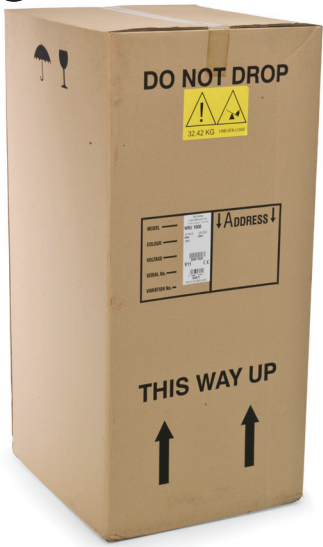

NR 40 / 50Kg  
NRT 40 / 50 Kg

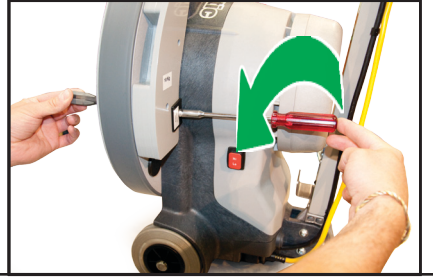

2B



3A



3B

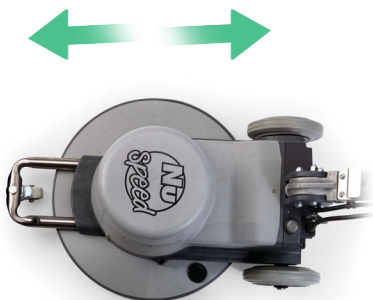

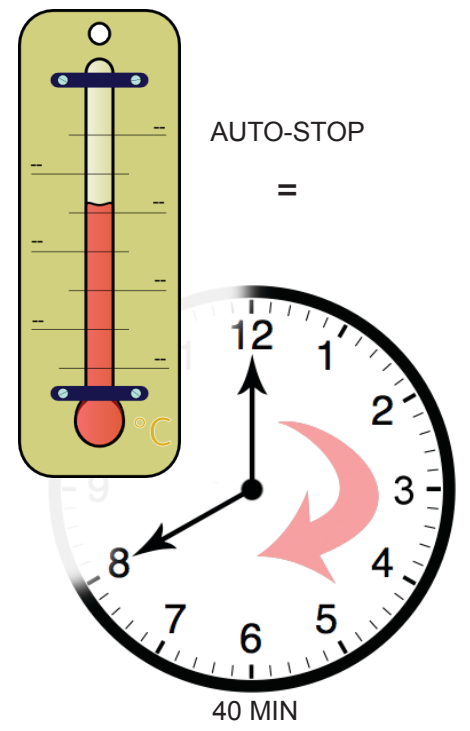
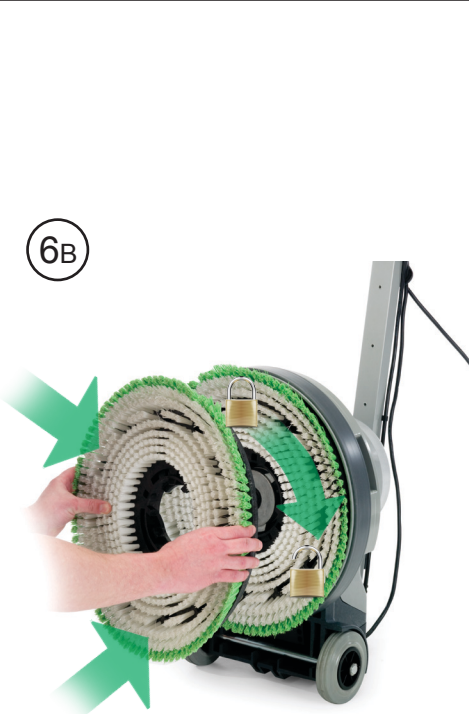
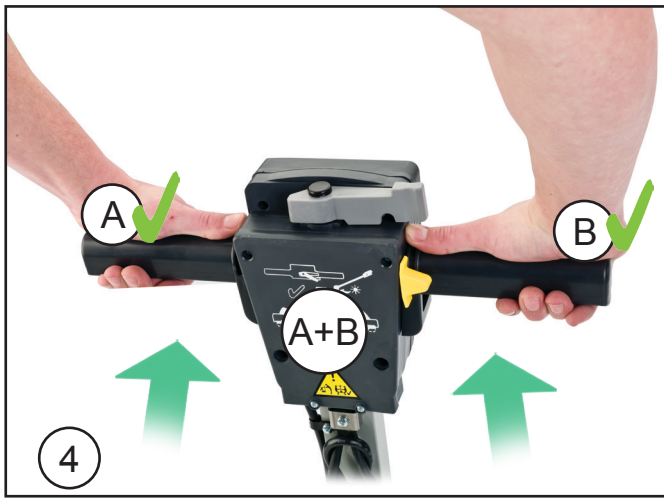

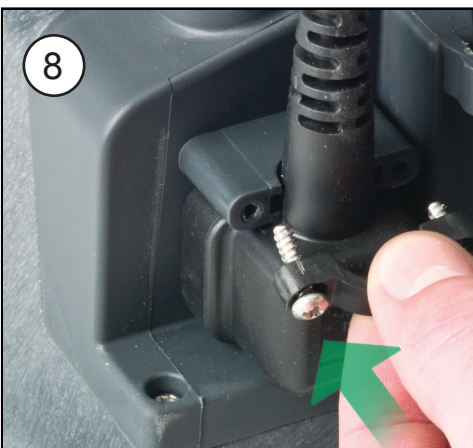
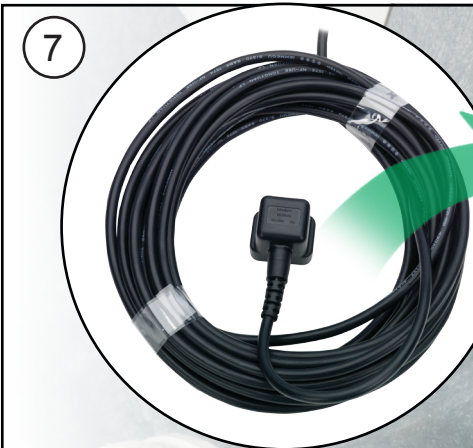
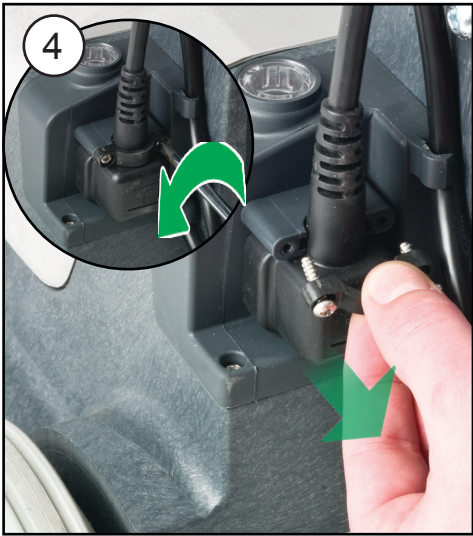
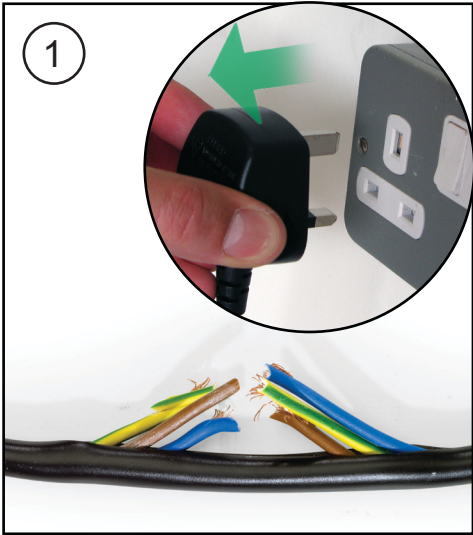

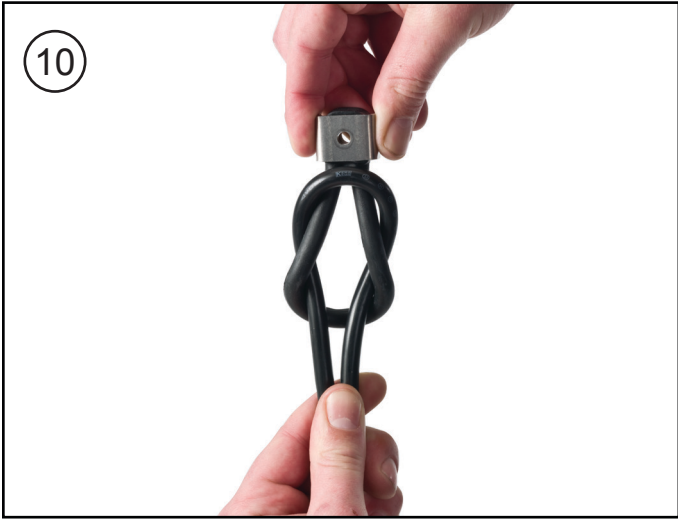



## Rating Label

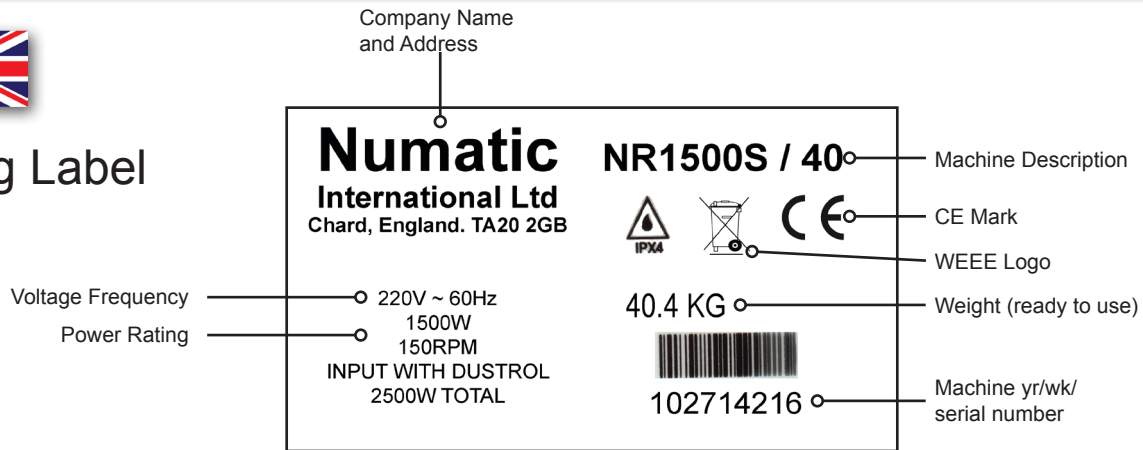

## Safety Critical Components

### Mains Lead

HO5VV-F x 15M x 3 x 1.5mm<sup>2</sup>

Floor Machine, accessories and packaging should be sorted for environmental-friendly recycling

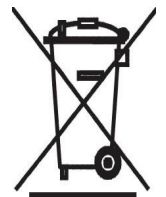

### Only for EU countries:

Do not dispose of Floor Machine into household waste!  
According to the European Directive 2002/96/EC on Waste Electrical and Electronic Equipment and its incorporation into national law. Floor Machine that are no longer suitable for use must be separately collected and sent for recovery in an environmentally - friendly manner.

**PPE**  
(personal protective equipment)  
that may be required for certain operations.



Safety Footwear



Hat Protection



Ear Protection



Safety Gloves



Dust / Allergens Protection



Eye Protection



Protective Clothing



Caution Floorsign

### NOTE:

A risk assessment should be conducted to decide what PPE should be worn.

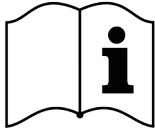

## ORIGINAL INSTRUCTIONS READ MANUAL BEFORE USE

### CAUTION:

Read the instruction manual before using the appliance

### NOTE:

This Product meets the requirements of BS EN 60335 - 2-67

This Machine is also suitable for commercial use, for example in hotels, schools, hospitals, factories, shops and offices for other the normal housekeeping purposes.

Care should be taken in the choice of chemicals, detergents and other liquids. Consult your supplier.

### Do's and Don'ts:

- DO Ensure only competent persons unpack/ assemble the machine.
  - DO Keep your machine clean.
  - DO Keep your brushes in good condition.
  - DO Replace any worn or damaged parts immediately.
  - DO Daily examine the mains lead for damage, such as cracking or aging. If damage is found, replace the lead before further use.
  - DO Only replace the mains lead with the correct Numatic approved replacement part.
  - DO Ensure that the work area is clear of obstructions and/ or people.
  - DO Ensure that the working area is well illuminated.
  - DO Pre - sweep the area to be cleaned.
  - DO Remove packing piece NR, NRT 40 / 50 Kg machines.
- 
- DON'T Use steam cleaners or pressure washers to clean the machine or use in the rain.
  - DON'T Attempt machine maintenance or cleaning unless the power plug has been removed from the supply outlet.
  - DON'T Allow any inexperienced repairs. Contact your nearest service centre.
  - DON'T Strain the mains lead or try to unplug by pulling on the mains lead.
  - DON'T Leave the brush deck in the lowered position when not in use.
  - DON'T Expect the machine to provide trouble free, reliable operation unless maintained correctly.
  - DON'T Run the machine over any power cables during operation.

### WARNING:

Operators shall be adequately instructed on the use of this machine.

This machine shall be disconnected from its power source (Remove plug from socket outlet.) During cleaning or maintenance or in the event of an accident and when replacing parts or converting the machine to another function.

This machine is not suitable for picking up hazardous dust.

Do not allow supply cord to come into contact with the rotating brushes or pads

As with all electrical equipment care and attention must be exercised at all times during its use, in addition to ensuring that routine and preventive maintenance is carried out

Periodically in order to ensure its safe operation. Failure to carry out maintenance as necessary, including the replacement of parts to the correct standard could render the equipment unsafe and the manufacturer can accept no responsibility or liability in this respect.

When ordering spare parts always quote the model number / serial number specified on the rating plate.

This machine is for indoor use only.

The machine is not to be used or stored outdoors or in wet conditions.

Don't allow the machine to be used by inexperienced or unauthorised operators or without appropriate training.

Only use brushes provided with the appliance or those specified in the instruction manual.

The use of other brushes may impair safety.

A full range of brushes and accessories are available for this product.

Only use brushes or pads which are suitable for the correct operation of the machine for the specific task being performed.

It is essential that this equipment is correct assembled and operated in accordance with current safety regulations. When using the equipment always ensure that all necessary precautions are taken to guarantee the safety of the operator and any other persons who may be affected.



## Produktplakette

Name und Anschrift des Unternehmens

**Numatic**  
International Ltd  
Chard, England. TA20 2GB

NR1500S / 40

Spannung / Frequenz: 220V ~ 60Hz  
Nennleistung: 1500W  
150RPM  
INPUT WITH DUSTROL  
2500W TOTAL

Bezeichnung der Maschine

CE-Kennzeichnung

WEEE Logo

(Nutz-) Gewicht: 40.4 KG

Gerät Jahr/Woche  
Seriennummer: 102714216

## Sicherheitsrelevante Bestandteile

### Stromversorgung

HO5VV-F x 15M x 3 x 1.5mm<sup>2</sup>

### WEEE-Richtlinie

Einscheibenmaschine, Zubehör und Verpackung müssen getrennt entsorgt werden, um ein umweltfreundliches Recycling zu ermöglichen.



### Für EU-Länder gilt:

Entsorgen Sie Einscheibenmaschine nicht im Hausmüll!

- gemäß EU-Richtlinie 2002/96/EC über die Entsorgung von Elektro- und Elektronikgeräten sowie deren Umsetzung in nationales Recht.

Einscheibenmaschine, die nicht mehr verwendet werden können, sind getrennt zu sammeln und zur umweltfreundlichen Entsorgung abzugeben.

In Deutschland sind das i.d.R. Sammelstellen beim örtlichen Entsorger.

### PSA

(PERSÖNLICHE SCHUTZAUSRÜSTUNG)

KANN FÜR BESTIMMTE ARBEITEN MIT DEM GERÄT ERFORDERLICH SEIN.



Sicherheitsschuhe



Kopfschutz



Ohrschutz



Sicherheitshandschuhe



Staub-/Allergieschutz



Augenschutz



Schutzkleidung



Hinweisschild „Achtung Rutschgefahr“

### Hinweis:

Zur Entscheidung, welche PSA zu tragen ist, sollte eine Risikoabschätzung vor Ort vorgenommen werden.

(Änderungen vorbehalten)



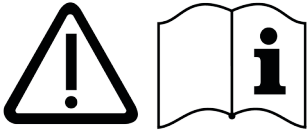

## ORIGINALANLEITUNG VOR GEBRAUCH AUFMERKSAM UND VOLLSTÄNDIG LESEN

### VORSICHT:

Lesen Sie das Handbuch gründlich durch, bevor Sie das Gerät einsetzen.

### ANMERKUNG:

Dieses Produkt erfüllt die Anforderungen gemäß BS EN 60335 - 2-67

Dieses Gerät ist zusätzlich zu seiner Verwendbarkeit in privaten Haushalten auch für den gewerblichen Einsatz geeignet, beispielsweise in Hotels, Schulen, Krankenhäusern, Fabriken, Läden und Büros.

Alle Chemikalien, Waschmittel und andere Flüssigkeiten sind mit Sorgfalt auszuwählen. Wenden Sie sich dazu an Ihren Anbieter.

### Worauf zu achten ist:

- Stellen Sie sicher, dass nur entsprechend befähigte Personen das Gerät auspacken/zusammenbauen.
- Halten Sie das Gerät sauber.
- Halten Sie die Bürsten in einem guten Zustand.
- Ersetzen Sie abgenutzte oder beschädigte Teile unverzüglich.
- Überprüfen Sie das Netzkabel täglich auf Beschädigungen, wie z. B. Risse oder Alterungserscheinungen. Wenn Sie feststellen, dass das Kabel beschädigt ist, ersetzen Sie es, bevor Sie weiterarbeiten.
- Ersetzen Sie das Netzkabel nur durch das korrekte, von Numatic genehmigte Ersatzteil.
- Stellen Sie sicher, dass sich keine Hindernisse oder Personen im Arbeitsbereich befinden.
- Achten Sie darauf, dass der Arbeitsbereich gut beleuchtet ist.
- Wischen Sie den zu reinigenden Bereich vor.
- Entfernen Sie die Transportsicherung an den NR, NRT 40, 50 kg Maschinen.
  
- Verwenden Sie KEINE Dampf- oder Druckreiniger zum Reinigen des Geräts, und verwenden Sie das Gerät NICHT im Regen.
- Führen Sie KEINE Wartungs- oder Reinigungsarbeiten am Gerät durch, wenn der Netzstecker noch in der Steckdose steckt.
- Lassen Sie Reparaturarbeiten NICHT von unerfahrenen Personen durchführen. Wenden Sie sich an das nächstgelegene Service-Center.
- Belasten Sie NICHT das Netzkabel, und versuchen Sie NICHT, den Netzstecker am Netzkabel herauszuziehen.
- Lassen Sie das Bürstendeck NICHT in der abgesenkten Position, wenn es nicht gebraucht wird.
- Gehen Sie davon aus, dass das Gerät NUR dann störungsfrei und zuverlässig betrieben werden kann, wenn es ordentlich gewartet wird.
- Fahren Sie mit dem Gerät im Einsatz NICHT über Strom führende Kabel.

### WARNUNG:

Benutzer müssen ausführlich in den Gebrauch dieses Geräts eingewiesen werden.

Dieses Gerät muss von seiner Stromversorgung getrennt werden (der Netzstecker muss gezogen werden), während das Gerät gereinigt oder gewartet wird, wenn es zu einem Unfall gekommen ist, wenn Teile am Gerät ausgetauscht werden oder wenn das Gerät in einen anderen Verwendungsmodus umgeschaltet wird.

Dieses Gerät ist nicht für die Aufnahme von gefährlichem Staub geeignet.

Rotierende Bürsten oder Pads dürfen nicht mit elektrischen Leitungen in Berührung kommen.

Wie bei allen elektrischen Geräten ist während der Benutzung jederzeit Vorsicht und Aufmerksamkeit geboten. Darüber hinaus muss zur Gewährleistung eines sicheren Betriebs in regelmäßigen Abständen eine laufende und vorbeugende Wartung durchgeführt werden. Wenn Sie die Wartung nicht im nötigen Umfang durchführen, darin eingeschlossen das Verwenden von korrekten Ersatzteilen, kann die Sicherheit des Geräts beeinträchtigt werden, und der Hersteller kann weder die Verantwortung noch eine Haftung in dieser Hinsicht übernehmen.

Nennen Sie bei der Bestellung von Ersatzteilen immer die Modell- oder Seriennummer, die auf dem Leistungsschild angegeben ist.

Dieses Gerät ist nur für den Einsatz im Innenbereich ausgelegt.

Das Gerät darf in Außenbereichen oder unter feuchten Bedingungen weder eingesetzt noch abgestellt werden.

Das Gerät darf nicht von unerfahrenen, nicht berechtigten bzw. nicht entsprechend geschulten Personen bedient werden.

Verwenden Sie nur die Bürsten, die zusammen mit dem Gerät geliefert wurden bzw. die im Handbuch angegeben sind.

Durch die Verwendung anderer Bürsten kann die Sicherheit beeinträchtigt werden.

Für dieses Produkt ist ein umfassender Satz an Bürsten und weiteren Zubehörteilen erhältlich.

Verwenden Sie nur Bürsten oder Pads, die für den korrekten Betrieb des Geräts bei der speziellen durchzuführenden Aufgabe geeignet sind.

Es ist entscheidend, dass dieses Gerät richtig zusammgebaut und entsprechend den aktuell geltenden Sicherheitsvorschriften bedient wird. Stellen Sie bei Verwendung des Geräts stets sicher, dass alle notwendigen Sicherheitsvorkehrungen umgesetzt wurden, um die Sicherheit des Bedieners sowie anderer, möglicherweise betroffener Personen zu gewährleisten.



## Plaque signalétique

Nom et adresse de la société

**Numatic International Ltd**  
Chard, England. TA20 2GB

220V ~ 60Hz  
1500W  
150RPM  
INPUT WITH DUSTROL  
2500W TOTAL

NR1500S / 40

IPX4

40.4 KG

102714216

Description de la machine

Marquage CE

Logo-DEEE

Poids

Année/Semaine/Numéro de série de la machine

Tension/Fréquence

Puissance

## Composants critiques pour la sécurité

### Câble d'alimentation

HO5VV-F x 15M x 3 x 1.5mm<sup>2</sup>

## Législation WEEE (DEEE)

Monobrosse, ses accessoires et son emballage doivent être triés pour un recyclage écologique.

Pays de l'UE uniquement :

Ne jetez pas Monobrosse avec les ordures ménagères.

Selon la directive européenne 2002/96/CE relative aux déchets d'équipements électriques et électroniques (DEEE) et à sa transposition au droit national,

Monobrosse qui ne sont plus utilisables doivent faire l'objet d'une collecte sélective et être traités d'une manière respectueuse de l'environnement.

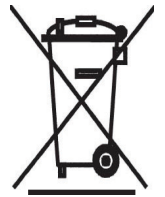

## EPI

(Équipement de protection individuelle)

Il peut être nécessaire pour certaines opérations.



Chaussures de sécurité



Casque de protection



Protections sonores



Gants de sécurité



Protection contre la poussière/les allergènes



Protection des yeux



Vêtements de protection



Panneau de signalisation au sol

## Note :

Une évaluation des risques devra être menée pour définir les obligations d'utilisation des EPI.

(sujet à modification sans préavis)

## Informations concernant Monobrosse



Veillez lire le manuel d'instruction avant d'utiliser l'appareil.  
Les utilisateurs doivent être correctement formés à l'utilisation de ces appareils.

### MISE EN GARDE :

Lisez le mode d'emploi avant d'utiliser l'appareil.

### REMARQUE :

Ce produit est conforme aux exigences de la norme BS EN 60335 - 2-67

Cette machine est également adaptée à un usage commercial, par exemple pour les hôtels, les écoles, les hôpitaux, les usines, les magasins et les bureaux à des fins autres que les besoins ménagers normaux.

Un soin particulier doit être pris dans le choix des produits chimiques, détergents et autres liquides. Consultez votre fournisseur.

### Choses à faire et à ne pas faire :

Veillez à ce que seules des personnes compétentes déballent/assemblent la machine.

Maintenez votre machine propre.

Maintenez vos brosses en bon état.

Remplacez immédiatement toute pièce usée ou endommagée.

Examinez régulièrement le câble d'alimentation pour voir s'il comporte des traces d'endommagement telles que des fissures ou un vieillissement. S'il est endommagé, remplacez-le avant toute nouvelle utilisation.

Remplacez le câble d'alimentation uniquement avec la pièce de rechange correcte approuvée par Numatic.

Assurez-vous que la zone de travail n'est pas encombrée et que personne ne passe par là.

Assurez-vous que la zone de travail est bien éclairée.

Balayez au préalable la zone à nettoyer.

Retirer morceau d'emballage NR, NRT 40 / 50 Kg machines.

N'utilisez pas de nettoyeurs à vapeur ou de nettoyeurs haute pression pour nettoyer la machine et évitez toute utilisation sous la pluie.

Ne procédez pas à l'entretien ou au nettoyage de la machine tant que celle-ci est branchée dans la prise de courant.

Ne laissez pas des personnes inexpérimentées effectuer des réparations. Contactez votre centre de service le plus proche.

N'exercez pas de traction excessive sur le câble, et ne débranchez jamais le câble en tirant dessus.

Ne laissez pas le plateau de brosses dans la position abaissée lorsqu'il n'est pas utilisé.

Ne négligez pas l'entretien de la machine si vous souhaitez qu'elle fonctionne de manière fiable et sans problème.

Ne roulez pas avec la machine sur des câbles électriques pendant l'utilisation.

### ATTENTION :

Les opérateurs doivent recevoir des instructions appropriées sur l'utilisation de ces machines.

Cette machine doit être débranchée de sa source d'alimentation (retirez la fiche secteur de la prise de courant) pendant le nettoyage ou l'entretien, ou en cas d'accident, ou pendant le remplacement de pièces ou la conversion de la machine pour changer de fonction.

Cette machine n'est pas conçue pour le ramassage de poussières dangereuses.

### Ne laissez pas de fil électrique entrer en contact avec les brosses ou disques

Comme pour tout équipement électrique, il convient d'être prudent et vigilant à tout instant lorsqu'on l'utilise, en plus de s'assurer que son entretien courant et préventif est bien effectué régulièrement pour qu'il reste en bon état de fonctionnement. Si l'entretien nécessaire n'est pas effectué et si l'on ne remplace pas les pièces à changer par des pièces à la bonne norme, l'équipement pourrait devenir dangereux et le fabricant ne pourra accepter aucune responsabilité à cet égard.

Lorsque vous commandez des pièces de rechange, indiquez toujours le numéro du modèle / numéro de série indiqué sur la plaque signalétique.

Cette machine est réservée à un usage intérieur.

La machine ne doit pas être utilisée ni rangée à l'extérieur ou dans un environnement humide.

Ne laissez pas des opérateurs inexpérimentés, non autorisés ou sans formation appropriée utiliser la machine.

Utilisez uniquement les brosses fournies avec l'appareil ou celles qui sont spécifiées dans le mode d'emploi.

L'utilisation d'autres brosses peut nuire à la sécurité.

Une gamme complète de brosses et d'accessoires est disponible pour ce produit.

N'utilisez que des brosses ou des disques qui sont appropriés pour le fonctionnement correct de la machine pour la tâche spécifique effectuée.

Il est essentiel que cet équipement soit correctement monté et utilisé conformément aux normes de sécurité actuelles. Lors de l'utilisation de l'équipement, veillez toujours à ce que toutes les précautions nécessaires soient prises pour garantir la sécurité de l'opérateur et de toute autre personne qui pourrait être concernée.



Type Plaatje

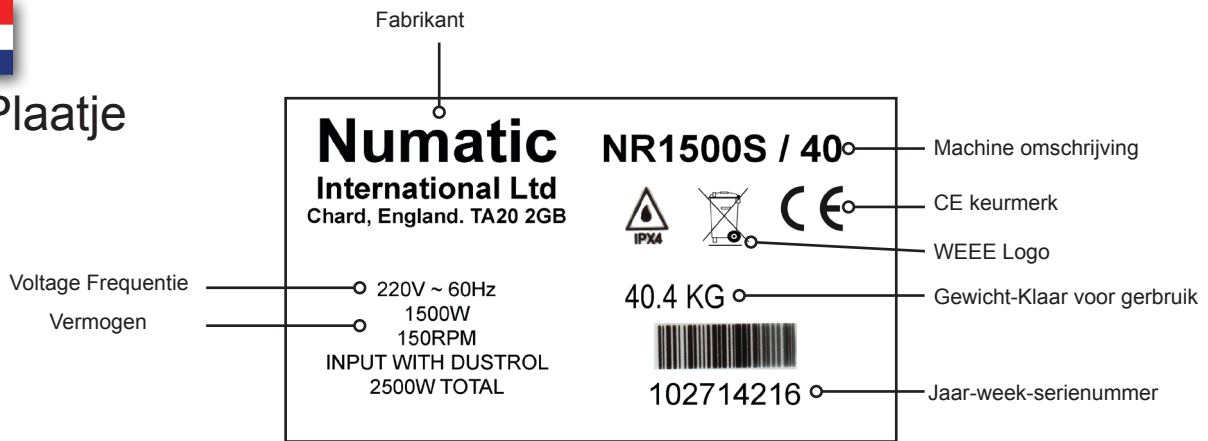

**Veiligheidsgevoelige componenten**

**Aansluitsnoer**

HO5VV-F x 15M x 3 x 1.5mm<sup>2</sup>

Eenschijf Machine, accessoires en verpakking dienen gesorterd te worden teneinde alle onderdelen milieuvriendelijk te weggooien

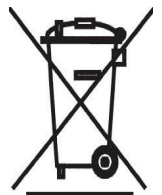

**Geldt alleen voor EU landen**

U mag Eenschijf Machine, volgens de Europese Richtlijn 2002/96/EN met betrekking tot het weggooien van elektronische apparatuur en zoals opgenomen in de Nederlandse wetgeving, niet met het huishoudelijk afval weggooien.

Eenschijf Machine die niet langer geschikt zijn voor gebruik moeten apart worden ingeleverd, zodat ze op een milieuvriendelijke manier kunnen worden verwerkt.

**PERSOONLIJKE BESCHERMING**

die vereist kan zijn bij het uitvoeren van bepaalde werkzaamheden



Veiligheidsschoeisel



Veiligheidshelm



Gehoorsbescherming



Veiligheidshandschoenen



Adembescherming



Oogbescherming



Beschermende kleding



Waarschuwbord

**LET OP:**

Een risico-inventarisatie dient te worden uitgevoerd teneinde te bepalen welke bescherming moet worden gebruikt.



## Originele gebruiksaanwijzing Lezen voor gebruik

### OPGELET:

Lees de gebruikershandleiding alvorens deze machine in gebruik te nemen

### OPMERKING:

Dit product voldoet aan de norm BS EN 60335 - 2-67

Deze machine is tevens geschikt voor zwaar gebruik, d.w.z. zwaarder dan huishoudelijk gebruik, zoals bijvoorbeeld in hotels, scholen, ziekenhuizen, fabrieken, winkels en kantoren.

Let erop dat u steeds geschikte chemische producten, schoonmaakmiddelen en andere vloeistoffen gebruikt. Raadpleeg hiervoor uw leverancier.

Wat WEL en wat NIET te doen:

WEL - zorg ervoor dat de machine alleen door ervaren personen worden uitgepakt/gemonteerd.

WEL - houd de machine schoon.

WEL - houd de borstels in goede staat.

WEL - vervang versleten of beschadigde onderdelen meteen.

WEL – controleer de stroomkabel regelmatig op beschadigingen, zoals scheurtjes of slijtage. Vervang het snoer wanneer het is beschadigd, voordat u de machine opnieuw gaat gebruiken.

WEL - Vervang de stroomkabel uitsluitend door het betreffende en door Numatic goedgekeurde vervangende onderdeel.

WEL - zorg ervoor dat er zich geen obstakels en/of mensen in de werkzone bevinden.

WEL - zorg ervoor dat de werkzone goed verlicht is.

WEL - veeg de zone die u gaat schoonmaken vooraf schoon.

WEL - Verwijder het verpakkingsmateriaal stuk NR, NRT 40 / 50 Kg machines

NIET - gebruik geen stoomreiniger of hogedrukspuit om de machine schoon te maken en gebruik de machine nooit in de regen.

NIET – onderhoud of reinig de machine niet terwijl de stekker in het stopcontact steekt.

NIET - laat nooit reparaties door onbevoegden uitvoeren. Neem daarvoor steeds contact op met het dichtstbijzijnde servicecentrum.

NIET – zorg ervoor dat de kabel nooit strak wordt gespannen en haal de kabel nooit uit het stopcontact door eraan te trekken.

NIET - laat de borstelplaat niet omlaag staan wanneer deze niet in gebruik is.

NIET - verwacht niet dat de machine probleemloos zal werken wanneer deze niet correct wordt onderhouden.

NIET – rijd tijdens bedrijf niet met de machine over de stroomkabel.

### WAARSCHUWING:

Gebruikers dienen goed geïnstrueerd te zijn voordat ze dit soort apparaat bedienen.

Deze machine dient van de stroombron te worden losgekoppeld (haal de stekker uit het stopcontact). Tijdens reiniging, onderhoud of reparatie van de machine, vervangen van onderdelen of het overschakelen naar een andere functie, dient de stroombron uitgeschakeld te zijn.

Deze machine mag niet worden gebruikt voor het opvegen van gevaarlijk stof.

Zorg ervoor dat het snoer niet in contact kan komen met draaiende borstels of pads

Zoals voor alle elektrische apparatuur dient tijdens gebruik steeds de nodige zorgvuldigheid in acht te worden genomen en moet regelmatig periodiek en preventief onderhoud worden uitgevoerd om de veiligheid van de machine te kunnen garanderen. Het niet uitvoeren van het nodige onderhoud of het vervangen van onderdelen door inferieure onderdelen, kan de veiligheid in gevaar brengen. De fabrikant kan hiervoor in geen geval aansprakelijk worden gesteld.

Vermeld bij het bestellen van reserveonderdelen steeds het op het kenplaatje vermelde modelnummer/serienummer.

Deze machine is uitsluitend voor gebruik binnen bestemd.

De machine mag niet buiten of in vochtige omgevingen worden gebruikt of opgeborgen.

De machine mag niet worden gebruikt door onervaren of onbevoegde bedieners die niet de nodige opleiding hebben gekregen.

Gebruik enkel borstels die bij de machine worden geleverd of borstels die uitdrukkelijk in de gebruikershandleiding staan vermeld.

Het gebruik van andere borstels kan de veiligheid in gevaar brengen.

Er is voor deze machine een volledig gamma borstels en accessoires verkrijgbaar.

Gebruik enkel borstels of pads die een goede werking van de machine en een correcte uitvoering van de betreffende taak garanderen.

Het is van het grootste belang dat deze machine correct wordt gemonteerd en bediend conform de geldende veiligheidsvoorschriften.

Let er bij het gebruiken van deze machine steeds op dat alle nodige voorzorgsmaatregelen worden genomen om de veiligheid van de bediener en mogelijke omstaanders te garanderen.

# Declaration of Conformity

**CE 13** **EU DECLARATION OF CONFORMITY**

We hereby declare under our sole responsibility that the following equipment fulfills all the relevant provisions of the following EU Directives:

Machinery Directive 2006/42/EC  
EMC Directive 2004/108/EC  
RoHS Directive 2011/65/EU

**Machine Description:** Floor Machine series  
**Type:** NPR, NR, NRL, NRT, NRS, NRU

**Manufactured by:** Numatic International Limited

Relevant standards upon which conformity is declared include:

IEC 60335-1 2001 + A1 2004 + A2 2006 + National Deviations  
IEC 60335-2:67 2002 + A1 2004

EN 55014-1:2006  
EN55014-2:1997+A1  
EN61000-3-2:2006  
EN61000-3-3:1995+A1+A2  
BS EN 50366:2003

A technical construction file for this equipment is retained at the manufacturer's address under the authorisation of the following signatory:

**Name:** Ailyn Boyes **Position:** Technical Manager

Signed: [Signature] Date: 01/01/2013

**Company:** Numatic International Limited, Chard, Somerset, TA20 2GB, www.numatic.co.uk

**GB**

**CE 13** **EU Konformitätserklärung**

Wir erklären in alleiniger Verantwortung, dass die folgenden Geräte alle einschlägigen Bestimmungen der folgenden EU-Richtlinien erfüllen:

Maschinenrichtlinie 2006/42/EC  
EMC Richtlinie 2004/108/EC  
RoHS Richtlinie 2011/65/EU

**Maschinenbezeichnung:** Einschleibemaschine  
**Type:** NPR, NR, NRL, NRT, NRS, NRU series

**Hersteller:** Numatic International Limited

Relevante Normen auf die Konformität erklärt wird beinhalten include:

IEC 60335-1 2001 + A1 2004 + A2 2006 + Nationale Abweichungen  
IEC 60335-2:67 2002 + A1 2004

EN 55014-1:2006  
EN55014-2:1997+A1  
EN61000-3-2:2006  
EN61000-3-3:1995+A1+A2  
BS EN 50366:2003

Eine technische Dokumentation für diese Geräte wird an der Adresse des Herstellers unter der Verantwortung des Unterzeichners aufbewahrt:

**Name:** Ailyn Boyes **Stellung:** Technischer Leiter

Unterschrift: [Signature] Datum: 01/01/2013

**Company:** Numatic International Limited, Chard, Somerset, TA20 2GB, www.numatic.co.uk

**DE**

**CE 13** **DECLARATION DE CONFORMITE EUROPEENNE**

Nous soussignés déclarons sous notre seule et unique responsabilité que les équipements suivants remplissent toutes les dispositions concernant les directives européennes suivantes:

Machinery Directive 2006/42/EC  
EMC Directive 2004/108/EC  
RoHS Directive 2011/65/EU

**Description Machine:** Monobrosses  
**Type:** NPR, NR, NRL, NRT, NRS, NRU

**Fabriqué par:** Numatic International Limited

La présente conformité inclut les normes d'applications suivantes:

IEC 60335-1 2001 + A1 2004 + A2 2006 + Dérogations Nationales  
IEC 60335-2:67 2002 + A1 2004

EN 55014-1:2006  
EN55014-2:1997+A1  
EN61000-3-2:2006  
EN61000-3-3:1995+A1+A2  
BS EN 50366:2003

Un dossier technique concernant la fabrication de cet équipement est conservé au siège social du fabricant sous l'autorisation du signataire suivant:

**Nom:** Ailyn Boyes **Position:** Responsable Technique

Signé par: [Signature] Date: 01/01/2013

**Company:** Numatic International Limited, Chard, Somerset, TA20 2GB, www.numatic.co.uk

**FR**

**CE 13** **EU CONFORMITEITSVERKLARING**

Wij verklaren hierbij dat de volgende producten zijn ontwikkeld en geproduceerd in overeenstemming met de volgende normen en voorschriften:

Machinery Directive 2006/42/EC  
EMC Richtlijn 2004/108/EC  
RoHS Richtlijn 2011/65/EU

**Omschrijving machine:** Enschijfsmachines  
**Model:** NPR, NR, NRL, NRT, NRS, NRU series

**Gefabriceerd door:** Numatic International Limited

Relevante normen waarop de conformiteit is verklaard, zijn inclusief:

IEC 60335-1 2001 + A1 2004 + A2 2006 + Nationale afwijkinge  
IEC 60335-2:67 2002 + A1 2004

EN 55014-1:2006  
EN55014-2:1997+A1  
EN61000-3-2:2006  
EN61000-3-3:1995+A1+A2  
BS EN 50366:2003

Technische specificaties m.b.t. de constructie van deze machines worden bewaard bij de fabrikant onder de verantwoordelijkheid van hieronder vermelde persoon:

**Naam:** Ailyn Boyes **Functie:** Manager Technical

Ondertekend: [Signature] Datum: 01/01/2013

**Company:** Numatic International Limited, Chard, Somerset, TA20 2GB, www.numatic.co.uk

**NL**

**CE 13** **DECLARACION DE CONFORMIDAD DE LA UNIÓN EUROPEA**

Declaramos bajo nuestra única responsabilidad que los siguientes equipos cumplen todas las disposiciones pertinentes de las siguientes Directivas de la UE:

Maquinaria, Directiva 2006/42/EC  
EMC, Directiva 2004/108/EC  
RoHS, Directiva 2011/65/EU

**Descripción de la Máquina:** Abrillantadoras  
**Tipos:** NPR, NR, NRL, NRT, NRS, NRU series

**Fabricado por:** Numatic International Limited

Normas pertinentes sobre las que se declara la conformidad, incluyen:

IEC 60335-1 2001 + A1 2004 + A2 2006 + Variantes Nacionales  
IEC 60335-2:67 2002 + A1 2004

EN 55014-1:2006  
EN55014-2:1997+A1  
EN61000-3-2:2006  
EN61000-3-3:1995+A1+A2  
BS EN 50366:2003

Existe un plano de fabricación en el sede del fabricante, disponible previa autorización del abajo firmante:

**Nombre:** Ailyn Boyes **Cargo:** Director Técnico

Firmado: [Signature] Fecha: 01/01/2013

**Company:** Numatic International Limited, Chard, Somerset, TA20 2GB, www.numatic.co.uk

**ES**

**CE 13** **DECLARAÇÃO DE CONFORMIDADE DA UNIÃO EUROPEIA (UE)**

Declaramos bajo nossa única responsabilidade que o seguinte equipamento cumpre todas as disposições constantes das seguintes diretivas técnicas da UE:

Directivas Técnicas de Equipamentos 2006/42/EC  
Directiva Técnica EMC 2004/108/EC  
Directiva Técnica RoHS 2011/65/EU

**Descrição do Equipamento:** Rotativas / Enceradoras  
**Tipos:** Series NPR, NR, NRL, NRT, NRS, NRU

**Manufacturado por:** Numatic International Limited

Normas sobre as quais a conformidade é declarada incluem:

IEC 60335-1 2001 + A1 2004 + A2 2006 + Especificações / Especificidades Nacionais  
IEC 60335-2:67 2002 + A1 2004

EN 55014-1:2006  
EN55014-2:1997+A1  
EN61000-3-2:2006  
EN61000-3-3:1995+A1+A2  
BS EN 50366:2003

No endereço do fabricante existe um arquivo de construção técnico para este equipamento, sob autorização do seguinte signatário:

**Nome:** Ailyn Boyes **Cargo:** Responsável Técnico

Assinado por: [Signature] Data: 01/01/2013

**Company:** Numatic International Limited, Chard, Somerset, TA20 2GB, www.numatic.co.uk

**PT**

**CE 13** **EU-SAMSVARERKLÆRING**

Vi erklærer herved under vårt fulle og hele ansvar at følgende utstyr overholder alle relevante forskrifter under følgende EU-direktiver:

Maskindirektiv 2006/42/EF  
EMC-direktiv 2004/108/EF  
RoHS-direktiv 2011/65/EU

**Beskrivelse av maskinen:** Gulvmaskiner  
**Type:** NPR, NR, NRL, NRT, NRS, NRU series

**Tilvirket av:** Numatic International Limited

Relevante standarder som avgjør overholdelse omfatter:

IEC 60335-1 2001 + A1 2004 + A2 2006 + Nasjonale avvik  
IEC 60335-2:67 2002 + A1 2004

EN 55014-1:2006  
EN55014-2:1997+A1  
EN61000-3-2:2006  
EN61000-3-3:1995+A1+A2  
BS EN 50366:2003

En teknisk konstruksjonsfil for dette utstyret finnes ved produsentens adresse med autorisasjon fra følgende signatør:

**Navn:** Ailyn Boyes **Plassering:** Teknologileder

Underskrift: [Signature] Dato: 01/01/2013

**Company:** Numatic International Limited, Chard, Somerset, TA20 2GB, www.numatic.co.uk

**NO**

**CE 13** **EG-Försäkran**

Vi intygar härmed under eget ansvar att följande utrustning uppfyller alla relevanta bestämmelser i följande EU-direktiv:

Maskindirektiv 2006/42/EC  
EMC-Direktiv 2004/108/EC  
RoHS-Direktiv 2011/65/EU

**Maskinbeskrivning:** Gulvmaskin  
**Modell:** NPR, NR, NRL, NRT, NRS, NRU serierna

**Tillverkad av:** Numatic International Limited

Relevanta standarder som EG-Försäkran baseras på inkluderar:

IEC 60335-1 2001 + A1 2004 + A2 2006 + Nationella avviker  
IEC 60335-2:67 2002 + A1 2004

EN 55014-1:2006  
EN55014-2:1997+A1  
EN61000-3-2:2006  
EN61000-3-3:1995+A1+A2  
BS EN 50366:2003

Teknisk konstruktionsunderlag för den här utrustningen behålls på tillverkarens adress och intygas av undertecknad med signatur:

**Namn:** Ailyn Boyes **Befattning:** Teknisk Chef

Undertecknad: [Signature] Datum: 01/01/2013

**Company:** Numatic International Limited, Chard, Somerset, TA20 2GB, www.numatic.co.uk

**SE**

**CE 13** **ΔΗΛΩΣΗ ΣΥΜΜΟΡΦΩΣΗΣ ΕΕ**

Με την παρούσα δηλώνουμε με αποκλειστική δική μας ευθύνη ότι ο παρακάτω εξοπλισμός πληροί όλες τις σχετικές διατάξεις του ακόλουθου Οδηγίου της ΕΕ:

Οδηγία 2006/42/ΕΚ σχετικά με τα μηχανήματα  
Οδηγία 2004/108/ΕΚ για την προστασία των νοσοκόμων των κρατών μέλη, σχετικά με την ηλεκτρομαγνητική συμβατότητα (Οδηγία EMC)  
Οδηγία 2011/65/ΕΕ για την προστασία της χρήσης ορισμένων επικίνδυνων ουσιών σε ηλεκτρικά και ηλεκτρονικά εξοπλισμό (Οδηγία RoHS)

**Περιγραφή μηχανήματος:** Περιτοριστική μηχανή καθαρισμού επίπλων  
**Τύπος:** Series NPR, NR, NRL, NRT, NRS, NRU

**Κατασκευαστής:** Numatic International Limited

Η δήλωση συμμόρφωσης βασίζεται στα εξής πρότυπα:

IEC 60335-1 2001 + A1 2004 + A2 2006 + Ηλεκτρική ασφάλεια  
IEC 60335-2:67 2002 + A1 2004

EN 55014-1:2006  
EN55014-2:1997+A1  
EN61000-3-2:2006  
EN61000-3-3:1995+A1+A2  
BS EN 50366:2003

Ο τεχνικός φάκελος κατασκευής του εξοπλισμού πρέπει στη διαθεσιμότητα του κατασκευαστή υπό την ευθύνη του ακόλουθου υπογράφοντα:

**Υπογραφή/όνομα:** Ailyn Boyes **Θέση:** Τεχνικός υπεύθυνος

Υπογραφή: [Signature] Ημερίνα: 01/01/2013

**Company:** Numatic International Limited, Chard, Somerset, TA20 2GB, www.numatic.co.uk

**GR**

**CE 13** **EU OVERENSSTEMMELSEERKLÆRING**

Vi bekræfter herved vores ansvar om at dette materiel opfylder alle relevante retningslinjer i henhold til EU direktiver:

Maskin direktiv 2006/42/EC  
EMC direktiv 2004/108/EC  
RoHS direktiv 2011/65/EU

**Maskin beskrivelse:** Gulvmaskine  
**Type:** NPR, NR, NRL, NRT, NRS, NRU series

**Produced af:** Numatic International Limited

Relevante standarder hvor overensstemmelseerklæring er deklareret inkluderer:

IEC 60335-1 2001 + A1 2004 + A2 2006 + Nationale afvigelser  
IEC 60335-2:67 2002 + A1 2004

EN 55014-1:2006  
EN55014-2:1997+A1  
EN61000-3-2:2006  
EN61000-3-3:1995+A1+A2  
BS EN 50366:2003

På producentens adresse vil producenten opbevare de tekniske specifikationer med en tegningsberettiget underskrift fra:

**Navn:** Ailyn Boyes **Stilling/betegnelse:** Teknisk chef

Underskrevet: [Signature] Dato: 01/01/2013

**Company:** Numatic International Limited, Chard, Somerset, TA20 2GB, www.numatic.co.uk

**DK**

**CE 13** **DICHIAZIONE DI CONFORMITA' UE**

Si dichiara sotto la propria esclusiva responsabilità che le seguenti apparecchiature soddisfano tutte le disposizioni relative alle seguenti direttive comunitarie:

Maskindirektiv 2006/42/EC  
Direttiva EMC 2004/108/EC  
Direttiva RoHS 2011/65/UE

**Descrizione della macchina**  
**Modello:** serie NPR, NR, NRL, NRT, NRS, NRU

**Prodotto da:** Numatic International Limited

Norme su cui si dichiara la conformità sono:

IEC 60335-1 2001 + A1 2004 + A2 2006 + Deroghe nazionali  
IEC 60335-2:67 2002 + A1 2004

EN 55014-1:2006  
EN55014-2:1997+A1  
EN61000-3-2:2006  
EN61000-3-3:1995+A1+A2  
BS EN 50366:2003

Un dossier tecnico di costruzione di questo apparecchio viene conservato presso l'indirizzo del fabbricante in base all'autorizzazione del seguente firmatario:

**Nome:** Ailyn Boyes **Qualifica:** Direttore tecnico

Firmato: [Signature] Data: 01/01/2013

**Company:** Numatic International Limited, Chard, Somerset, TA20 2GB, www.numatic.co.uk

**IT**

**CE 13** **EU YHDENKUKAISUUSTODISTUS**

Vakuutamme omalla vastuullamme, että seuraavat laitteet täyttävät kaikki asianmukaisesti seuraavat EU-direktiivien määräykset:

Koneidirektiivi 2006/42/EC  
EMC Direktiivi 2004/108/EC  
RoHS Direktiivi 2011/65/EU

**Koneen kuvaus:** Lattiainhoitokone  
**Tyyppi:** NPR, NR, NRL, NRT, NRS, NRU series

**Valmistaja:** Numatic International Limited

Asiaa koskevat standardit, joihin vaatimuskonemuksilusta vakuutaan sisältävät:

IEC 60335-1 2001 + A1 2004 + A2 2006 + Kansallisia eroja  
IEC 60335-2:67 2002 + A1 2004

EN 55014-1:2006  
EN55014-2:1997+A1  
EN61000-3-2:2006  
EN61000-3-3:1995+A1+A2  
BS EN 50366:2003

Tämän laitteen tekninen rakennuskuvaus säilytetään valmistajan osoitteessa allekirjoitettuna valtuuttamana:

**Alekkijohdos:** Ailyn Boyes **Asema:** Tekninen Johtaja

Alekkijohdos: [Signature] Päivä: 01/01/2013

**Company:** Numatic International Limited, Chard, Somerset, TA20 2GB, www.numatic.co.uk

**FI**

**CE 13** **EUROPEJSKA DEKLARACJA ZGODNOŚCI**

Niniejszym oświadczamy z pełną odpowiedzialnością, że wyżej wymieniony produkt spełnia wszystkie wymogi określone w poniższych dyrektywach Unii Europejskiej:

Dyrektywa Maszynowa 2006/42/EC  
Dyrektywa EMC 2004/108/EC  
Dyrektywa RoHS 2011/65/EU

**Oplek maszyny:** Odkurzacz  
**Model:** seria NPR, NR, NRL, NRT, NRS, NRU

**Wyprodukowano przez:** Numatic International Limited

Deklarowana zgodność obejmuje poniższe normy:

IEC 60335-1 2001 + A1 2004 + A2 2006 + Odstępstwa krajowe  
IEC 60335-2:67 2002 + A1 2004

EN 55014-1:2006  
EN55014-2:1997+A1  
EN61000-3-2:2006  
EN61000-3-3:1995+A1+A2  
BS EN 50366:2003

Dokumentacja techniczna dotycząca wymienionego produktu jest przechowywana przez producenta za uwzględnieniem:

**Imię i Nazwisko:** Ailyn Boyes **Stanowisko:** Kierownik Techniczny

Podpis: [Signature] Data: 01/01/2013

**Company:** Numatic International Limited, Chard, Somerset, TA20 2GB, www.numatic.co.uk

**PL**

**CE 13** **DECLARAȚIE DE CONFORMITATE UE**

Declaram prin prezenta pe proprie răspundere că următoarele echipamente îndeplinesc toate dispozitiile relevante ale directivelor UE de mai jos:

Directiva 2006/42/CE privind echipamentele tehnice  
Directiva 2004/108/CE privind compatibilitatea electromagnetică  
Directiva 2011/65/UE privind restricțiile de utilizare a anumitor substanțe periculoase în echipamentele electrice și electronice

**Descrierea echipamentului:** Echipamente pentru podole  
**Tip:** serie NPR, NR, NRL, NRT, NRS, NRU

**Fabricate de:** Numatic International Limited

Standardele relevante pe baza cărora este declarată conformitatea includ:

IEC 60335-1 2001 + A1 2004 + A2 2006 + Abateri naționale  
IEC 60335-2:67 2002 + A1 2004

EN 55014-1:2006  
EN55014-2:1997+A1  
EN61000-3-2:2006  
EN61000-3-3:1995+A1+A2  
BS EN 50366:2003

Un dosar de construcție tehnică pentru acest echipament este păstrat la adresa producătorului sub autorizarea următorului semnatar:

**Nume:** Ailyn Boyes **Funcție:** Director tehnic

Semnătura: [Signature] Data: 01/01/2013

**Company:** Numatic International Limited, Chard, Somerset, TA20 2GB, www.numatic.co.uk

**RO**

**CE 13** **EL VASTAVUSDEKLARATSIIOON**

Kaesoolevaga kinnitame ja kanname vastutus selle eest, et alljärgnevat tootet vastavad kõigile EL direktiivide sätetele.

Masinate Direktiiv 2006/42/EC  
EMC Direktiiv 2004/108/EC  
RoHS Direktiiv 2011/65/EU

**Masina kirjeldus:** Põrandahoidumasinad  
**Tüüp:** NPR, NR, NRL, NRT, NRS, NRU seeria

**Tooja:** Numatic International Limited

Deklareeritavate standardite vastavus käsitleb:

IEC 60335-1 2001 + A1 2004 + A2 2006 + Riiklikud erisused  
IEC 60335-2:67 2002 + A1 2004

EN 55014-1:2006  
EN55014-2:1997+A1  
EN61000-3-2:2006  
EN61000-3-3:1995+A1+A2  
BS EN 50366:2003

Selle masina tehniline dokumentatsioon on tootja nimel ja loale kinnitatud järgneva allkirjaga:

**Nimi:** Ailyn Boyes **Ametitkoht:** Tehniline juht

Allkirj: [Signature] Kuupäev: 01/01/2013

**Company:** Numatic International Limited, Chard, Somerset, TA20 2GB, www.numatic.co.uk

**EE**

**CE 13** **PROHLÁŠENÍ O SHODĚNÍ O**

Prohlášeji na svou výlučnou odpovědnost, že následující zařízení splňuje veškeré relevantní ustanovení těchto směrnice EU:

Směrnice 2006/42/ES pro strojíni zařízení  
Směrnice 2004/108/ES o elektromagnetické kompatibilitě  
Směrnice RoHS 2011/65/ES

**Popis zařízení:** Podlahové stroje  
**Typ:** řada NPR, NR, NRL, NRT, NRS, NRU

**Výrobce:** Numatic International Limited

Normy, podle nichž je shoda deklarována:

IEC 60335-1 2001 + A1 2004 + A2 2006 + Odchyly v jednotlivých zemích  
IEC 60335-2:67 2002 + A1 2004

EN 55014-1:2006  
EN55014-2:1997+A1  
EN61000-3-2:2006  
EN61000-3-3:1995+A1+A2  
BS EN 50366:2003

Technická konstrukční dokumentace pro toto zařízení je uložena na adrese výrobce, a to na základě povolení následujícího osobou:

**Jméno:** Ailyn Boyes **Funkce:** Technický ředitel

Podpis: [Signature] Datum: 01/01/2013

**Company:** Numatic International Limited, Chard, Somerset, TA20 2GB, www.numatic.co.uk

**CZ**

**CE** 13  
**EU MEGFELELŐSÉGI NYILATKOZÁS**  
 Ezzel a közlönyben felelősségi körökben kijelentjük, hogy a következő készülék megfelel a következő EU irányelvek összes hatályos rendelkezésének:  
 A gépektről szóló 2006/42/EK irányelv  
 Az elektromágneses összeférhetőségre vonatkozó 2004/108/EK irányelv  
 Az Európai Parlament és a Tanács 2011/65/EU irányelve (RoHS)  
**A gép megnevezése: Padlópolító gépek**  
**Típus: NPR, NR, NRL, NRT, NRS, NRU sorozat**  
**Gyártó: Numatic International Limited**  
 Vonatkozó szabványok, melyek alapján a megfelelőséget nyilvánították:  
 IEC 60335-1 2001 + A1 2004 + A2 2006 + Nemzeti eltérések  
 IEC 60335-2-67 2002 + A1 2004  
 EN 55014-1:2006  
 EN55014-2:1997+A1  
 EN61000-3-2:2006  
 EN61000-3-3:1995+A1+A2  
 BS EN 50366:2003  
 A készülékhez műszaki dokumentáció áll rendelkezésre a gyártó címen, a következő alábbi engedélyezésre alapítva:  
**Név: Ailyn Boyes Beosztás: Műszaki igazgató**  
 Aláírás: Datum: 01/01/2013  
 Numatic International Limited,  
 Chard, Somerset,  
 TA20 2GB  
 www.numatic.co.uk **HU**

**CE** 13  
**ДЕКЛАРАЦИЯ ЗА СЪОТВЕТСТВИЕ С ИЗИСКВАНИЯТА НА ЕС**  
 С настоящата декларираме под наша собствена отговорност, че следното оборудване удовлетворява всички приложими изисквания на следните директиви на ЕС:  
 Директива за машини 2006/42/ЕО  
 Директива за електромагнитна съвместимост 2004/108/ЕО  
 Директива за ограничаване на опасните вещества 2011/65/ЕО  
**Описание на машината: Машини за почистване на подове**  
**Тип: Серии NPR, NR, NRL, NRT, NRS, NRU**  
**Произведена от: Numatic International Limited**  
 Приложимите стандарти, на база на които се декларира съответствието, включват:  
 IEC 60335-1 2001 + A1 2004 + A2 2006 + Отклонение от национални стандарти  
 IEC 60335-2-67 2002 + A1 2004  
 EN 55014-1:2006  
 EN55014-2:1997+A1  
 EN61000-3-2:2006  
 EN61000-3-3:1995+A1+A2  
 BS EN 50366:2003  
 Файл за техническата конструкция на това оборудване се съхранява на адреса на производителя под пълномощието на следното длъжностно лице:  
**Име: Ailyn Boyes Длъжност: Технически мениджър**  
 Подпис: Дата: 01/01/2013  
 Numatic International Limited,  
 Chard, Somerset,  
 TA20 2GB  
 www.numatic.co.uk **BG**

**CE** 13  
**ES ATITIKTIES DEKLARACIJA**  
 Prisiškindami visą atsakomybę šiuo dokumentu pareiškiame, kad toliau nurodyta įranga atitinka šią ES direktyvų nuostatas:  
 Masinų direktyva 2006/42/EB  
 EMS direktyva 2004/108/EB  
 Pavojingų medžiagų naudojimo apribojimo direktyva 2011/65/ES  
**Prietaiso aprašymas: Grindų plovimo įrenginiai**  
**Tipas: NPR, NR, NRL, NRT, NRS, NRU serija**  
**Gamintojas: Numatic International Limited**  
 Susiję standartai, kuriais remiantis buvo deklaruota atitikties:  
 IEC 60335-1 2001 + A1 2004 + A2 2006 + Nacionaliniai nuokrypiai  
 IEC 60335-2-67 2002 + A1 2004  
 EN 55014-1:2006  
 EN55014-2:1997+A1  
 EN61000-3-2:2006  
 EN61000-3-3:1995+A1+A2  
 BS EN 50366:2003  
 Šios įrangos techninę gamybos bylą galima saugoti pas gamintoją, leidus šiam pasirašiusiajam asmeniui:  
**Varidas, pavadė Ailyn Boyes Pareigos: Techninės priežiūros vadovas**  
 Pasirašė: Data: 01/01/2013  
 Numatic International Limited,  
 Chard, Somerset,  
 TA20 2GB  
 www.numatic.co.uk **LT**

**CE** 13  
**DEKLARACIJA EU O SKLADNOSTI**  
 Izjavljamo pod izključno odgovornostjo, da je naslednja oprema skladna z vsemi ustreznimi določbami naslednjih direktiv EU:  
 Direktiva 2006/42/ES o strojih,  
 Direktiva 2004/108/ES o elektromagnetni združljivosti,  
 Direktiva 2011/65/EU o omejevanju uporabe nevarnih nevarnih snovi v električni in elektronski opremi.  
**Opis aparata: Aparati za čiščenje tal**  
**Vrsta: seriji NPR, NR, NRL, NRT, NRS, NRU**  
**Proizvajalec: Numatic International Limited**  
 Ustrežni standardi, na katerih temelji izjava o skladnosti, obsegajo:  
 IEC 60335-1 2001 + A1 2004 + A2 2006 + Nacionalna odstopanja  
 IEC 60335-2-67 2002 + A1 2004  
 EN 55014-1:2006  
 EN55014-2:1997+A1  
 EN61000-3-2:2006  
 EN61000-3-3:1995+A1+A2  
 BS EN 50366:2003  
 Tehnična konstrukcijska mapa za to opremo se hrani na naslovu proizvajalca, zanj pa je zadolžen naslednji podpisnik:  
**Ime: Ailyn Boyes Funkcija: Tehnični direktor**  
 Podpis: Datum: 01/01/2013  
 Numatic International Limited,  
 Chard, Somerset,  
 TA20 2GB  
 www.numatic.co.uk **SI**

# Floor Machines Application Chart (NU-Speed Range)

		Scarifying 4, 5, 6	Stripping 7,	Shampoo 3,	Spray Cleaning	Wet Scrubbing 2, 8, 9	Dry Buffing 1, 9	Light Spray Buff 9,	Low Gloss Polish 1,	Medium Gloss Polish 1, 9	High Speed Gloss Polish 9,	Extra High Gloss Polish Burnish
NRT 1530HD	1000W				●	●			●			
	150RPM											
	1250W						●	●		●		
	300RPM											
NR-1500S	1500W	●	●	●	●	●			●			
	150RPM											
NR-1500M	1500W		●	●		●			●			
	230RPM											
NR-1500H	1500W					●	●	●	●			
	300RPM											
NRS-450	1500W				●		●	●		●	●	
	450RPM											
NRU-1500	1500W	Pad Size 400mm Ultra High Speed Pads Only									◆	◆
	1500RPM											

## Numatic Brush Description

- 1) Union Mix Polishing Brush FMA-606102, FMA-606202, FMA-606702 (Bristles Brown).
- 2) Polypropylene Scrubbing Brush FMA-606105, FMA-606203, FMA-606703 (Outer Bristles Green).
- 3) Nylon Wet Shampoo Brush FMA-606108, FMA-606204, FMA-606704 (All Bristles White).
- 4) Scarifying Wire Brush FMA-606114, FMA-606706 Floor Preparation
- 5) Three Head Silicon Carbide Grinding Discs FMA-606208 Floor Preparation
- 6) Spirotex FMA-606211 Six Head Heavy Duty Scarifying Brush Floor Preparation
- Floortec Padless Brush System (Colour Coded Centre Bristles)**
- 7) Black Centre Coded, Heavy Duty Scrubbing And Stripping FMA-606301/FT400-1, FMA-606305/FT450-1, FMA-606315/FT500-1.
- 8) Green Centre Coded, All Purpose General Scrubbing Brush FMA-606302/FT400-2, FMA-606306/FT450-2, FMA-606316/FT500-2.
- 9) Red Centre Coded, Light Scrubbing When Wet, General polishing When Dry FMA-606303/FT400-3, FMA-606307/FT450-3, FMA-606317/FT500-3.

## NOTE:

10Kg & 20Kg Weight, use only on **standard speed** machines for wet/dry scrubbing, vitrification and crystallisation.

**WARNING.** FMA-606056 vacuum kits are for dry pick up only **DO NOT** use on wet surfaces.

## IMPORTANT

**Only use the socket outlet on the appliance for Numatic recommended products.**



Model	Motor	Speed	Optional Vacuum	Brush	Pad	Range	Weight	Sound Pressure dB(A)@1.7m	HAV M/S <sup>2</sup>	Dimensions
NR-1500S	1500W	150rpm	NTD130	450mm	400mm	32m	40Kg	68.1	1.1	1250x580x460mm
NR-1500M	1500W	230rpm	NTD130	450mm	400mm	32m	40Kg	69.4	0.8	1250x580x460mm
NR-1500H	1500W	300rpm	NTD130	450mm	400mm	32m	40Kg	70.4	1	1250x580x460mm
NRL-1500	1500W	150rpm	NTD130	550mm	500mm	32m	40Kg	70.2	1.1	1250x610x540mm
NRT-1530	1000W/1250W	150/300rpm	NTD130	450mm	400mm	32m	40Kg	69.2	1.92	1250x580x460mm
NRS-450	1500W	450rpm	NTD130	450mm	400mm	32m	35Kg	68.4	1.58	1250x580x460mm
NRU-1500	1500W	1500rpm	NTD130		400mm	32m	35Kg	64.8	1.84	1250x660x460mm

HAV = Hand Arm Vibration



Modell	Motor	Drehzahl	Absaugung (optional)	Bürste	Pad	Arbeitsradius	Gewicht	Schalldruckpegel dB(A)@1.7m	HAV M/S <sup>2</sup>	Abmessungen
NR-1500S	1500W	150rpm	NTD130	450mm	400mm	32m	40Kg	68.1	1.1	1250x580x460mm
NR-1500M	1500W	230rpm	NTD130	450mm	400mm	32m	40Kg	69.4	0.8	1250x580x460mm
NR-1500H	1500W	300rpm	NTD130	450mm	400mm	32m	40Kg	70.4	1	1250x580x460mm
NRL-1500	1500W	150rpm	NTD130	550mm	500mm	32m	40Kg	70.2	1.1	1250x610x540mm
NRT-1530	1000W/1250W	150/300rpm	NTD130	450mm	400mm	32m	40Kg	69.2	1.92	1250x580x460mm
NRS-450	1500W	450rpm	NTD130	450mm	400mm	32m	35Kg	68.4	1.58	1250x580x460mm
NRU-1500	1500W	1500rpm	NTD130		400mm	32m	35Kg	64.8	1.84	1250x660x460mm

HAV = Hand-/Armvibration



Model	Moteur	VITESSE	SYSTÈME D'EXTRACTION (EN OPTION)	Brosse	Disque	RAYON DE TRAVAIL	Poids	Niveau de pression sonore dB(A)@1.7m	HAV M/S <sup>2</sup>	Dimensions
NR-1500S	1500W	150rpm	NTD130	450mm	400mm	32m	40Kg	68.1	1.1	1250x580x460mm
NR-1500M	1500W	230rpm	NTD130	450mm	400mm	32m	40Kg	69.4	0.8	1250x580x460mm
NR-1500H	1500W	300rpm	NTD130	450mm	400mm	32m	40Kg	70.4	1	1250x580x460mm
NRL-1500	1500W	150rpm	NTD130	550mm	500mm	32m	40Kg	70.2	1.1	1250x610x540mm
NRT-1530	1000W/1250W	150/300rpm	NTD130	450mm	400mm	32m	40Kg	69.2	1.92	1250x580x460mm
NRS-450	1500W	450rpm	NTD130	450mm	400mm	32m	35Kg	68.4	1.58	1250x580x460mm
NRU-1500	1500W	1500rpm	NTD130		400mm	32m	35Kg	64.8	1.84	1250x660x460mm

HAV = Mesure des vibrations main-bras



Model	Motorkop	Toeren	Optionele afzuiging	Borstel	Pad	Bereik	Gwicht	Geluidsdruk dB(A)@1.7m	HAV M/S <sup>2</sup>	Afmeting
NR-1500S	1500W	150rpm	NTD130	450mm	400mm	32m	40Kg	68.1	1.1	1250x580x460mm
NR-1500M	1500W	230rpm	NTD130	450mm	400mm	32m	40Kg	69.4	0.8	1250x580x460mm
NR-1500H	1500W	300rpm	NTD130	450mm	400mm	32m	40Kg	70.4	1	1250x580x460mm
NRL-1500	1500W	150rpm	NTD130	550mm	500mm	32m	40Kg	70.2	1.1	1250x610x540mm
NRT-1530	1000W/1250W	150/300rpm	NTD130	450mm	400mm	32m	40Kg	69.2	1.92	1250x580x460mm
NRS-450	1500W	450rpm	NTD130	450mm	400mm	32m	35Kg	68.4	1.58	1250x580x460mm
NRU-1500	1500W	1500rpm	NTD130		400mm	32m	35Kg	64.8	1.84	1250x660x460mm

HAV = Trilling hand / arm



# FLOOR MACHINE HAZARDOUS REGULATION INFORMATION.



Under certain uses, this machine may be subject to the Provision and Use of Work Equipment Regulations (council directive 89/655/EEC), Control of Substances Hazardous to Health Regulations, Dangerous Substances and Explosive Atmospheres Regulations and other Safety Regulations (council directive 98/24/EC & 99/92/EC). User must ensure that their use of this machine for any purpose meets these requirements.  
Regular inspection and maintenance of this machine in accordance with the manufacturer's recommendations and the above Regulations is essential for its functional and safe operation.

---



Bei bestimmten Einsätzen unterliegt diese Maschine möglicherweise der Arbeitsmittel-Benutzungsrichtlinie (Richtlinie 89/655/EEC des Rates), der Richtlinie zum Schutz von Gesundheit und Sicherheit der Arbeitnehmer vor der Gefährdung durch chemische Arbeitsstoffe bei der Arbeit, der ATEX-Betreiberrichtlinie für Explosionsschutz und anderen Sicherheitsrichtlinien (Richtlinie 98/24/EG & 99/92/EG des Rates). Der Benutzer muss sicherstellen, dass der Einsatz dieser Maschine für jeden Zweck diese Anforderungen erfüllt.  
Für den einwandfreien und sicheren Betrieb dieser Maschine ist ihre regelmäßige Inspektion und Wartung in Übereinstimmung mit den Herstellerhinweisen und den o. g. Richtlinien von grundlegender Bedeutung.

---



Pour certaines utilisations, cette machine pourra être soumise aux réglementations suivantes : Directive 89/655/CEE du Conseil concernant les prescriptions minimales de sécurité et de santé pour l'utilisation par les travailleurs au travail d'équipements de travail  
"Provision and Use of Work Equipment Regulations".

-Directives 98/24/CE et 99/92/CE du Conseil du Conseil concernant la protection de la santé et de la sécurité des travailleurs contre les risques liés à des agents chimiques sur le lieu de travail et autres réglementations concernant la sécurité "Control of Substances Hazardous to Health Regulations, Dangerous Substances and Explosive Atmospheres Regulations and other Safety Regulations".

Les utilisateurs doivent s'assurer que leur usage de cette machine pour une application quelconque soit bien conforme à ces exigences.

Afin que cette machine fonctionne correctement et en toute sécurité, il est essentiel qu'elle soit périodiquement contrôlée et entretenue conformément aux recommandations du constructeur et aux Réglementations ci-dessus.

---



In zekere gebruiksomstandigheden, zijn de Europese Arbeidsmiddelenrichtlijn (Europese richtlijn 89/655/EEC), de richtlijnen voor de beheersing van gevaarlijke stoffen, gevaarlijke stoffen en explosieve omgevingen en andere dergelijke veiligheidsnormen (Europese richtlijnen 98/24/EC & 99/92/EC) van toepassing op deze machine. De gebruiker dient dus zeker te stellen dat de wijze waarop deze machine wordt gebruikt voor welk doel dan ook steeds aan deze veiligheidsnormen voldoet.

Deze machine dient regelmatig te worden gecontroleerd en onderhouden overeenkomstig de aanbevelingen van de fabrikant en de bovenstaande reglementen dienen nauwgezet te worden nageleefd voor een optimale en



1



2

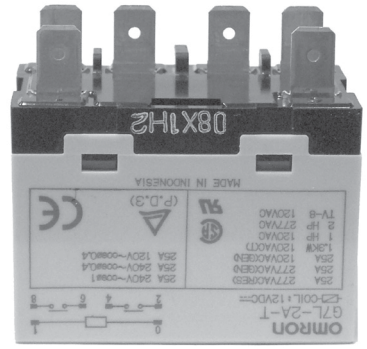

3



4



5

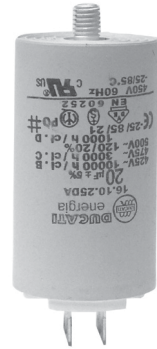

6

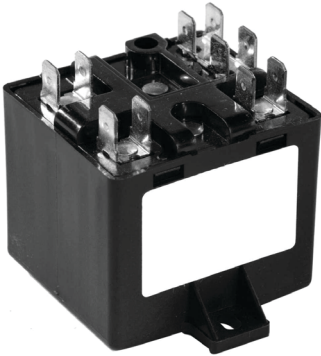

7

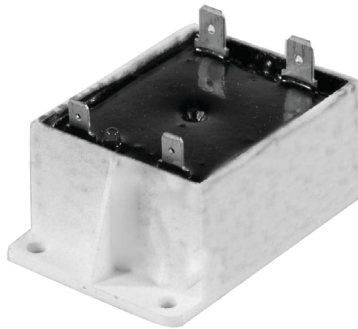

8



9



10



11



12



13



14

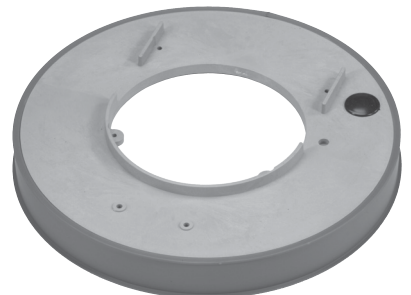

15

# Spare Parts



		NR1500 S/M/H	NRT 1530	NRU 1500	NRS 450	NRL 1500
1	MOTOR					
	4 pole / 220 - 240v 50Hz	205217	205217			205217
	4 pole / 220 - 240v 50Hz (NO SEAL)			205218		
	4 pole / 220 - 60Hz	205219	205219			205219
	2 pole / 220 - 240v 50Hz				205222	
	2/4 pole / 220 - 240v 50Hz		205223			
2	GEARBOX					
		230206 / S	230206			230206
		230210 / M			230210	
		230209 / H				
3	230V RELAY	206575	206575	206575	206575	206575
4	12v DC FAN	205072	205072	205072	205072	205072
5	START CAPACITOR	208265	208265	208265	208265	208265
6	RUN CAPACITOR	220876	220876	220876	220876	220876
7	VOLTAGE RELAY					
	SINGLE SPEED	206823		206823	206823	206823
	TWO SPEED		206824			
8	UNIVERSAL POWER SUPPLY	206753	206753	206753	206753	206753
9	SOCKET	220964	220964	220964	220964	220964
10	HI LO SWITCH		229465			
11	WHEEL KIT	304267	304267	304268	304267	304267
12	HANDLE SWITCH	229454	229454	229454	229454	229454
13	CABLE					
	UK	236072	236072	236072	236072	236072
	EUROPEAN	236136	236136	236136	236136	236136
	SWISS	236078	236078	236078	236078	236078
	S/A	236081	236081	236081	236081	236081
	AUSTRALIAN	236087	236087	236087	236087	236087
14	HANDLE	577445	577445	577445	577445	577445
15	DECK	606361	606361	329369	606361	606362





# Ersatzteile

		NR1500 S/M/H	NRT 1530	NRU 1500	NRS 450	NRL 1500
1	MOTOR					
	4 pole / 220 - 240v 50Hz	205217	205217			205217
	4 pole / 220 - 240v 50Hz OHNE FASE			205218		
	4 pole / 220 - 60Hz	205219	205219			205219
	2 pole / 220 - 240v 50Hz				205222	
	2/4 pole / 220 - 240v 50Hz		205223			
2	GETRIEBE					
		230206 / S	230206			230206
		230210 / M			230210	
		230209 / H				
3	230V RELAIS	206575	206575	206575	206575	206575
4	12V DC LÜFTER	205072	205072	205072	205072	205072
5	ANLAUFKONDENSATOR	208265	208265	208265	208265	208265
6	BETRIEBSKONDENSATOR	220876	220876	220876	220876	220876
7	SPANNUNGSRELAIS					
	1 DREHZAHL	206823		206823	206823	206823
	2 DREHZAHL		206824			
8	UNIVERSELLER NETZAN- SCHLUSS	206753	206753	206753	206753	206753
9	STECKDOSE	220964	220964	220964	220964	220964
10	HI LO SCHALTER		229465			
11	RAD BAUSATZ	304267	304267	304268	304267	304267
12	SCHALTER	229454	229454	229454	229454	229454
13	ZULEITUNG					
	UK	236072	236072	236072	236072	236072
	EUROPÄISCH	236136	236136	236136	236136	236136
	SCHWEIZ	236078	236078	236078	236078	236078
	SÜDAFRIKA	236081	236081	236081	236081	236081
	AUSTRALIEN	236087	236087	236087	236087	236087
14	HANDGRIFF	577445	577445	577445	577445	577445
15	DECK	606361	606361	329369	606361	606362



# Pièces Détachées



		NR1500 S/M/H	NRT 1530	NRU 1500	NRS 450	NRL 1500
1	MOTEUR					
	4 pole / 220 - 240v 50Hz	205217	205217			205217
	4 pole / 220 - 240v 50Hz SANS JOINT			205218		
	4 pole / 220 - 60Hz	205219	205219			205219
	2 pole / 220 - 240v 50Hz				205222	
	2/4 pole / 220 - 240v 50Hz		205223			
2	RÉDUCTEUR					
		230206 / S	230206			230206
		230210 / M			230210	
		230209 / H				
3	230V RELAIS	206575	206575	206575	206575	206575
4	12v DC VENTILATEUR	205072	205072	205072	205072	205072
5	CONDENSATEUR DE DÉMARRAGE	208265	208265	208265	208265	208265
6	CONDENSATEUR DE MARCHE	220876	220876	220876	220876	220876
7	RELAY DE TENSION					
	1 VITESSE	206823		206823	206823	206823
	2 VITESSE		206824			
8	ALIMENTATION UNI- VERSELLE	206753	206753	206753	206753	206753
9	FICHE	220964	220964	220964	220964	220964
10	HI LO CONTACT		229465			
11	ROUE KIT	304267	304267	304268	304267	304267
12	POIGNÉE CONTACT	229454	229454	229454	229454	229454
13	CÂBLE					
	UK	236072	236072	236072	236072	236072
	EUROPÉEN	236136	236136	236136	236136	236136
	SUISSE	236078	236078	236078	236078	236078
	AFRICAIN DU SUD	236081	236081	236081	236081	236081
	AUSTRALIEN	236087	236087	236087	236087	236087
14	POIGNÉE	577445	577445	577445	577445	577445
15	PONT / PLATEFORME	606361	606361	329369	606361	606362





# Reserve onderdelen

		NR1500 S/M/H	NRT 1530	NRU 1500	NRS 450	NRL 1500
1	MOTOR					
	4 pole / 220 - 240v 50Hz	205217	205217			205217
	4 pole / 220 - 240v 50Hz GEEN PAKKING			205218		
	4 pole / 220 - 60Hz	205219	205219			205219
	2 pole / 220 - 240v 50Hz				205222	
	2/4 pole / 220 - 240v 50Hz		205223			
2	TANDWIELOVERBRENGING					
		230206 / S	230206			230206
		230210 / M			230210	
		230209 / H				
3	230V RELAIS	206575	206575	206575	206575	206575
4	12v DC Waaier	205072	205072	205072	205072	205072
5	START CONDENSATOR	208265	208265	208265	208265	208265
6	RUN CONDENSATOR	220876	220876	220876	220876	220876
7	RELAIS					
	1 Toeren	206823		206823	206823	206823
	2 Toeren		206824			
8	UNIVERSELE STROOMVOORZIENING	206753	206753	206753	206753	206753
9	STOPCONTACT	220964	220964	220964	220964	220964
10	HI LO SCHAKELAAR		229465			
11	WIEL KIT	304267	304267	304268	304267	304267
12	HANDEL SCHAKELAAR	229454	229454	229454	229454	229454
13	SNOER					
	GB	236072	236072	236072	236072	236072
	EUROPEES	236136	236136	236136	236136	236136
	ZWITSERLAND	236078	236078	236078	236078	236078
	ZUID AFRIKAANS	236081	236081	236081	236081	236081
	AUSTRALISCH	236087	236087	236087	236087	236087
14	HANDEL	577445	577445	577445	577445	577445
15	BORSTELHUIS	606361	606361	329369	606361	606362



# NRT ( 2 Speed) 230V (Floor Machine)

WD-348 (A07) 21.09.11

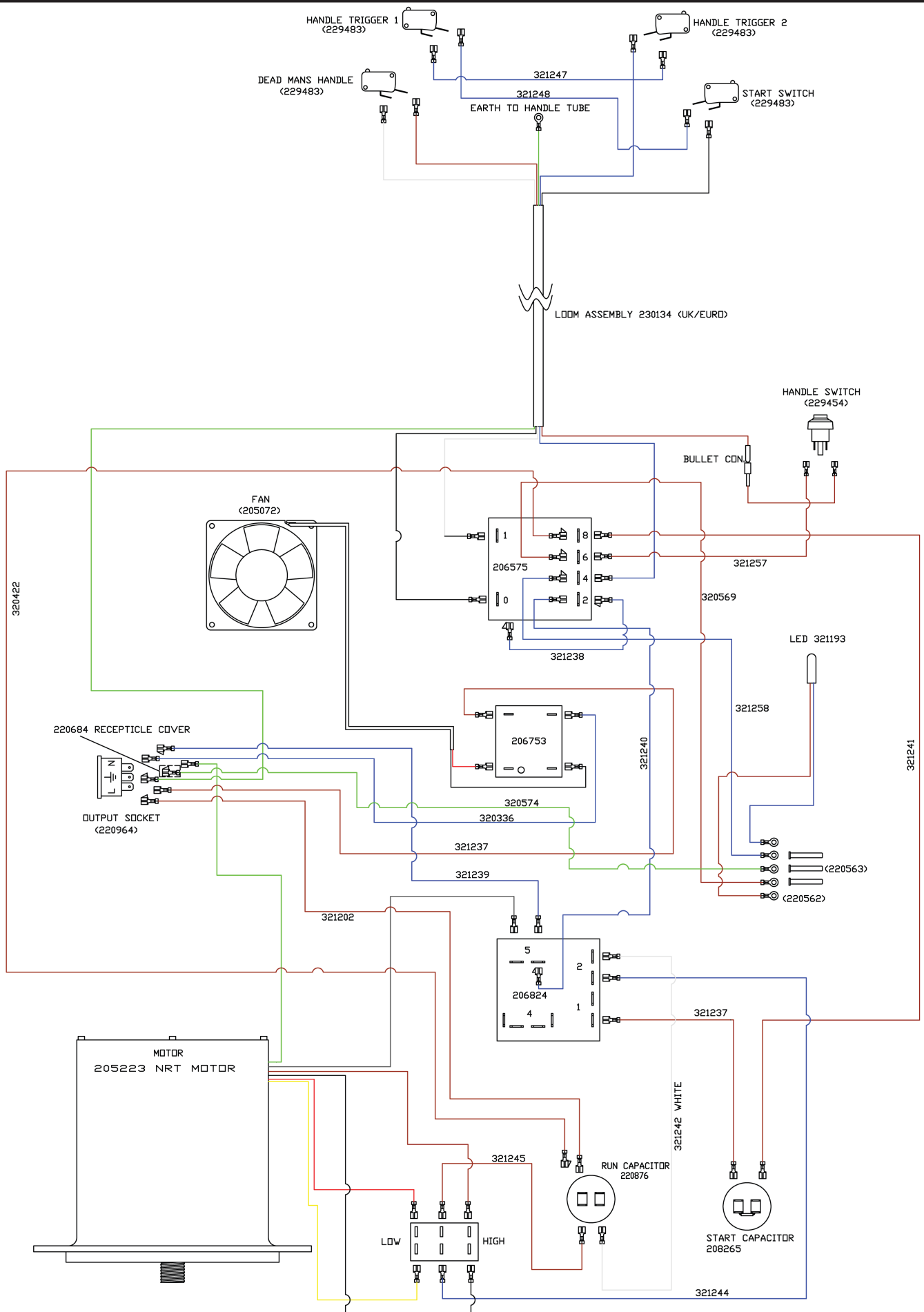

# NR / NRU / NRS / NRL 230V (Floor Machine)

WD-0345 (A06) 20.09.11

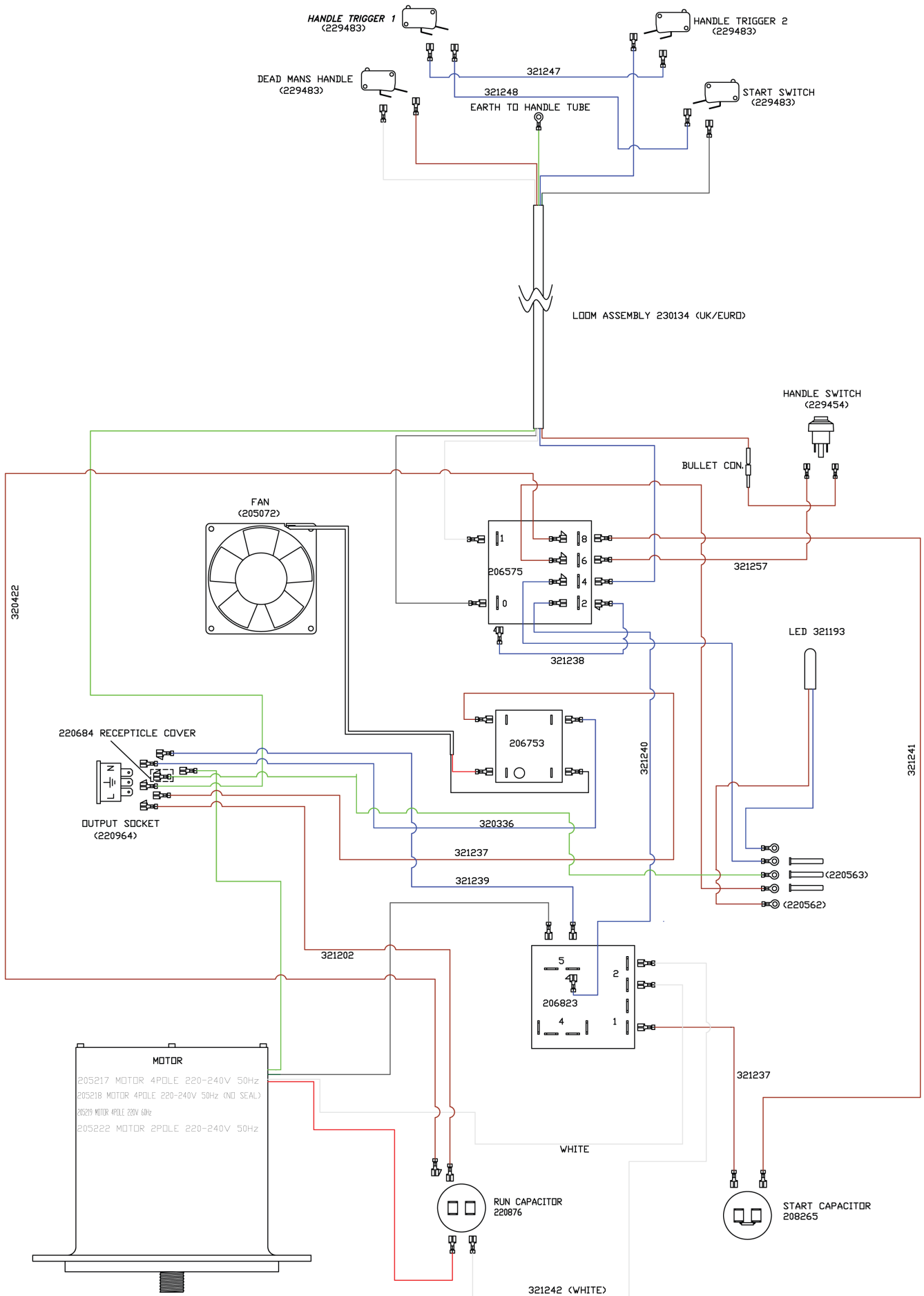



# Nuspeed Accessories

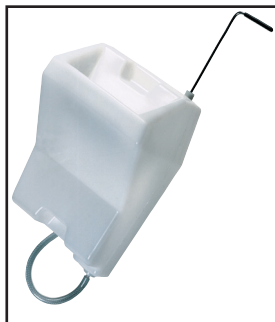

FMA- 606084 NuSpeed Soloution Tank.



FMA-606113:- NuSpeed extra external 10Kg weight for NR 1500S (40Kg to 50Kg)



FMA-606206:- 400mm Nuloc Pad Drive Board



FMA-606054:- NR optional spraytec Kit



FMA-606202:- 450m Union Mix Polish Brush



FMA-606700:- 400m Porcupine Pad Holder



FMA-606056:- NR Dustrol Kit

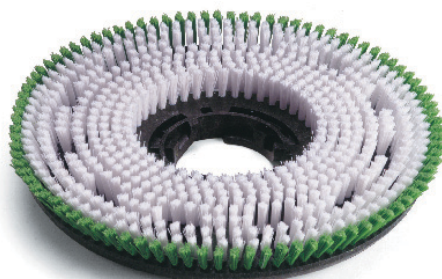

FMA-606203:- 450 Polyscrub Brush



FMA-60115:- 550mm Union mix Polish brush



FMA-606079:- NR/NPR Dustrol Control Brush Ring



FMA-606204:- 450mm Nyloscrub Brush

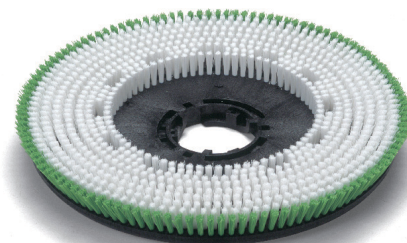

FMA-606028 550mm Polyscrub Brush

**- 150rpm - 30Kg / 40Kg / 50Kg**

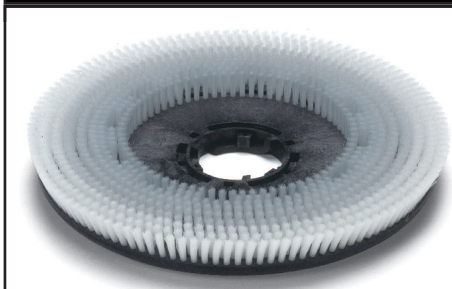

FMA-606550:-550mm Nyloscrub Brush



FMA-606307:- FT 450/3 Floortec Longlife Light Scrubbing Brush.

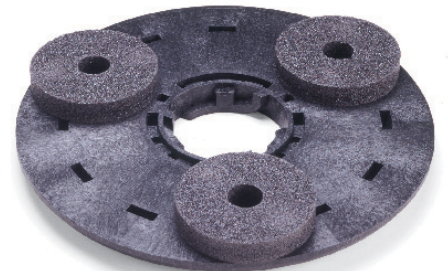

FMA-606208:- 400mm Carbotex Grinding Disc



FMA-606034:- 500mm Nu-loc Pad Drive Board



FMA-606308:- 450/4/ Floortec High Lustre Polish Brush



FMA-606209:- 400m Sandotex Disc Drive



FMA-606305:- FT 450/1 Floortec Heavy Duty Scrubbing/ Stripping Brush

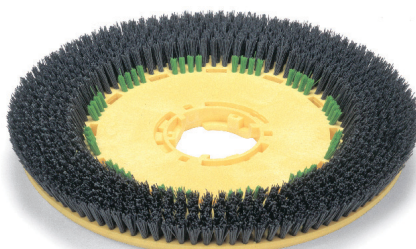

FMA-606551:- 550mm Floortec Longlife Brush



FMA-606211:- 400mm Heavy Duty Scarifying Disc - Spirotex 6 head



FMA-606306:- 450mm floortec Longlife Brush

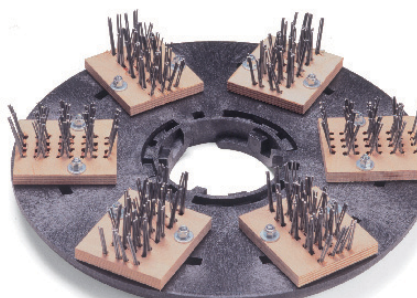

FMA-606207:- 400mm Wire Scarifying Brush



## Specialised Accessories - 300rpm



FMA - 606857 Flexi - Pad Drive for use with top quality pads

## Specialised Accessories - 450rpm



FMA - 606087  
Spider Drive Universal High - Speed  
Polishing Brush



FMA - 606078  
Spider High - Speed  
Pad Drive



FMA - 606086  
Spider Drive  
High - Speed Short Trim  
Burnishing Brush



FMA - 606088  
Spider Drive Floortec  
High - Speed Long Life  
Polishing Brush



Distributed By:



This Product has been comprehensively inspected and checked during every stage of its manufacture, including an in-depth electrical safety and functionality test.



Numatic International Limited, Chard, Somerset, TA20 2GB, ENGLAND.

Telephone 01460 68600 Fax: 01460 68458

[www.numatic.co.uk](http://www.numatic.co.uk)



Numatic International GmbH, Fränkische Straße 15-19,  
30455 Hannover, DEUTSCHLAND.

Tel: 05 11 98 42 16 0 Fax: 05 11 98 42 16 20

[www.numatic.de](http://www.numatic.de)



Numatic International S.A., 13/17 rue du Valengelier, EAE la Tuilerie, 77500  
Chelles, FRANCE. Tel: 01 64 72 61 61 Fax: 01 64 72 61 62

[www.numatic.fr](http://www.numatic.fr)



BenNeLux Distribution, Numatic International BV, Postbus 101, 2400 AC  
Alphen den Rijn, NEDERLAND. Tel: 0172 467 999 Fax : 0172 467 970

[www.numatic.nl](http://www.numatic.nl)



Numatic International (Pty.) Ltd. 16th & Pharmaceutical Roads,  
Midrand, Gauteng, S.A. 1685. Tel: 0861 686 284 Fax: 0861 686 329

[www.numatic.co.za](http://www.numatic.co.za)



Numatic International Schweiz AG. Sihlbruggstrasse 142,  
6340 Baar. SCHWEIZ. Tel: 0041 (0) 41 76 80 76 - 0.

Fax: 0041 (0) 41 76 80 76 - 9.

[www.numatic.ch](http://www.numatic.ch)

*Specification subject to change without prior notice.*

**www.numatic.co.uk © Numatic International Limited**

*Specification subject to change without prior notice*

**www.numatic.co.uk © Numatic International Limited**