



TASKI®

balimat 2300

Instruction Manual
(Translation of the Original Version)

EN

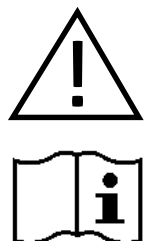

CONTENTS

This operating manual contains instructions for using the sweeper.

Carefully keep the operating manual so that you can refer to it later.

Our products are being continuously improved. Design changes after going to print may therefore not be considered. If you have any questions, please contact our Service department (for contact details, see page 18).



Carefully study the operating manual and the general safety instructions before you unpack the machine any further or undertake first start up.

The operating manual is to be read attentively and followed by any person that operates the sweeper.

PROPER USE

Only use the sweeper according to the specifications in this operating manual.

The sweeper is only intended for sweeping hard standing areas (e.g.: car parks, pavements, warehouses). The sweeping environment must not be wet.

The sweeper must only be operated by reliable, instructed personnel.

Prevent it from being used by children, young people and other unauthorised persons, e.g. by removing the key after use.

Any other usage beyond this is deemed to be improper use (see "Safety Instructions", page 13). The manufacturer is not liable for any damage resulting from this.

The user is solely responsible for the risk.

Proper use also includes following the operating manual, the safety instructions and keeping to the servicing and maintenance specifications.

Only operate in expressly assigned routes and places.

Observe the maximum climbing ability specified in the technical data and maximum possible slope inclination for operating across slopes. Due to an abrupt change of direction, particularly on slopes, the sweeper may tip. Adapt your operating manner and speed to the conditions.

Follow the instructions on suitable ground (asphalt, screed, industrial floors, concrete, paving stones etc.)

EXPLANATION OF SYMBOLS

⚠ DANGER!indicates a possibly dangerous situation that can cause death or serious injuries.

⚠ CAUTION!indicates a possibly dangerous situation that can cause minor injuries.

⚠ WARNING ...indicates a possibly dangerous situation that may cause material damage.

i INSTRUCTIONindicates important information.

EC DECLARATION OF CONFORMITY

EC Declaration of Conformity According to the EC Machinery Directive 2006/42/EC, Annex II 1.A

We hereby declare that the machine designated below complies with the essential safety and health requirements of the EC Machinery Directive in its design and construction and in the version marketed by us.

Mister Kai Stolzenberg - Management of Stolzenberg GmbH & Co. KG, Hamburger Straße 15-17, 49124 Georgsmarienhütte - be authorized to compile the technical documentation.

Manufacturer: Stolzenberg GmbH & Co. KG
Hamburger Straße 15-17
D-49124 Georgsmarienhütte

Description of the machine: Suction Sweeper with Tandem-Roller-System

Machine type: balimat 2300

Applicable EC Directives: 2006/42/EG
2014/30/EU
2000/14/EG

Applied harmonized standards,
in particular:

| | |
|--------------------|---------|
| DIN EN 60335-1: | 2020-08 |
| DIN EN 60335-2-72: | 2014-09 |
| DIN EN 55012: | 2010-04 |
| DIN EN 61000-6-2: | 2019-11 |
| DIN EN 61000-3-2: | 2019-12 |
| DIN EN 61000-3-3: | 2020-07 |

Georgsmarienhütte, 12.01.2021

 Kai Stolzenberg
(General Manager)

RATING PLATE

The rating plate is attached on the top of the frame below the front panel.



| | | |
|---|--------------|----------------------------|
| balimat 2300 | | EAC CE |
| MODEL: | balimat 2300 | |
| SERIAL NUMBER: | XXXXXXX | |
| PROTECTION: | IPX3 | |
| GVW: | 74 kg | |
| VOLTAGE: | 12 V | |
| POWER: | 0,23 kW | |
| Stolzenberg GmbH & Co. KG Hamburger Str. 15-17 49124 Georgsmarienhütte Germany www.stolzenberg.de | | max. 2% Made in Germany |

CONSTRUCTION, FUNCTION, TECHNICAL DATA

The TwinSweep balimat 2300 is a battery-operated, hand-driven pedestrian-controlled vacuum sweeper fitted with the tandem roller system (TRS).

The TRS allows large sweeping materials to be swept up without difficulty. The sweeper has a powerful vacuum function.

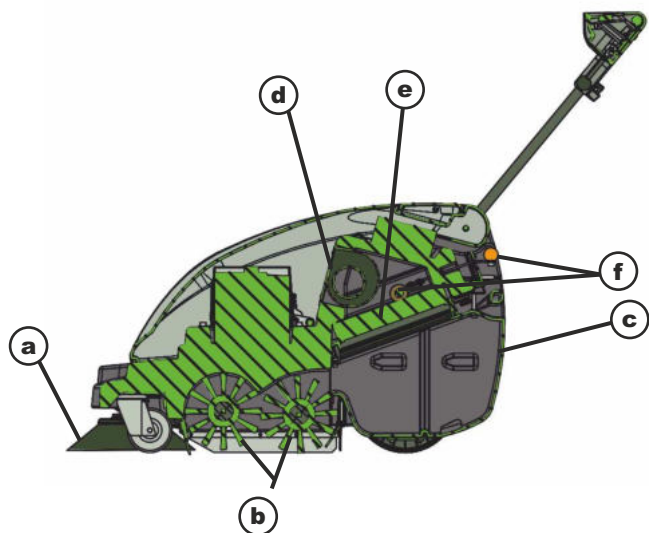
FUNKTION

In the tandem roller system (TRS), sweeping materials are first conveyed by means of the **side brush (a)** from the corners and edges of the sweeping area into the centre of the machine and therefore towards the two counter-rotating **roller brush (b)**.

From this, the sweeping material is taken up and conveyed into the **dirt-hopper (c)** situated at the back.

The dust stirred up by the sweeping process is vacuumed up by a **vacuuming system (fan) (d)**, filtered by **flat-pleat filter (e)** and thus separated from the clean air.

Mechanical filter cleaning (f) removes the dust caked onto the flat-pleat filter and allows this to drop into the dirt-hopper.

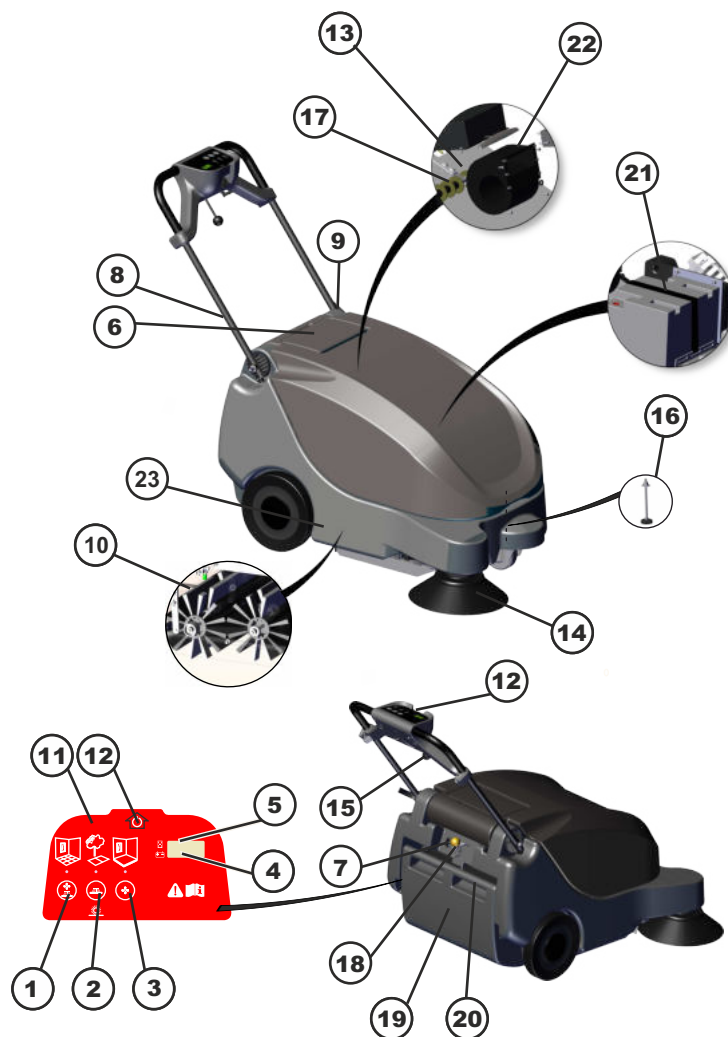
OPERATING AND FUNKTIONAL COMPONENTS**Overview:****Machine Components:**

1. Vacuum, Side Brush, Roller Brush Start Button
2. Side Brush, Roller Brush Start Button
3. Vacuum, Roller Brush Start Button
4. Battery Discharge Indicator
5. Charge Indikator / Hour Meter
6. Battery Charger Cord Storage Compartment
7. Battery Charger Outlet
8. Transport Bar
9. Adjustable Control Handle Lever
10. Roller Brushes
11. Control Panel
12. Power Button
13. Flat-Pleat Filter
14. Side Brush
15. Side Brush Adjusting Lever
16. Internal Access Knob
17. Filter Cleaning (Filter Shaker)
18. Shaker Rod
19. Dirt - Hopper,
20. Dirt - Hopper Handle
21. Battery
22. Vacuuming System (Fan)
23. Anti-static Chain

TECHNICAL DATA**Technical Data**

| | |
|--|---|
| Model | balimat 2300 |
| Length | 923 mm / 37 in |
| Width | 650 mm / 25 in |
| Height | 557 mm / 22 in |
| Weight | 55 kg / 121 lb |
| Sweeping Path Width | 620 mm / 24 in |
| Main Brush Width | 400 mm / 16 in |
| Side Brush Diameter | 300 mm / 12 in |
| Hopper Capacity | 37 L / 9.8 Gal |
| Battery Capacity | 12 V, 50 Ah |
| Total Power Consumption | 12 VDC, 230 W, 12.6 A |
| Battery Charger | 100-240VAC 8A |
| Productivity Rate (Net) | 1290 m ² /hr / 13850 ft ² /hr |
| Slope Maximum | 2% |
| Machine Vibration at Hand-arm * | <2.5m/s ² |
| Machine Vibration Uncertainty K * | 0.8 m/s ² |
| Sound Pressure Level L _{pA} * | 62 dBA |
| Sound Uncertainty K _{pA} * | 3 dBA |
| Sound Power Level L _{WA} + Uncertainty K _{WA} * | 81 dB(A) |
| Protection Grade | IPX3 |
| Operation Temperature | min. -15°C, max. 40°C |

* Values determined as per EN 60335-2-72

SAVETY**SAVETY INSTRUCTIONS**

As well as the operating manual and the binding regulations for accident prevention applicable in the country of usage and at the place where it is deployed, recognised rules for safety and expert working, and environmental protection, are also to be followed.

SAFETY INSTRUCTIONS FOR OPERATION

- The machine is to be inspected before usage for its perfect condition and operational safety. If it is not in perfect condition, it must not be used.
- In particular, have any errors that may affect safety rectified immediately.
- Operating the machine in buildings at risk of explosion is prohibited.
- Sweeping up of flammable, toxic or explosive materials and combustible gases or undiluted acids and solvents, burning or smouldering objects is prohibited.
- The device is not suitable for accepting fluids, ropes, twines, wires or similar items.
- Only use the machine with the dirt-hopper inserted to prevent injuries due to parts being projected.
- Do not make any alterations or additions to the machine without the approval of the manufacturer.
- Persons (including children) who, due to their physical, sensory or mental capacities or their inexperience or lack of knowledge, are not capable of using the machine safely must not use this machine without the supervision or instruction of a responsible person. Children must be supervised to ensure that they do not play with the machine.
- Caution: Loose items of clothing may be drawn into rotating parts and cause serious or fatal injuries.
- Transporting loads with the sweeper is not permitted.
- Observe the maximum climbing ability specified in the technical data and maximum possible slope inclination for operating across slopes. The equipment may tip, particularly on slopes. Adapt your operating manner and speed to the conditions.
- The machine is not permitted for use on roads.
- Suitable, non-slip footwear is to be worn to avoid accidents.

SAFETY INSTRUCTIONS ON BATTERIES

- The operating instructions of the battery manufacturer for their product and the specifications of the legislator on handling batteries are to be followed.
- Charge flat batteries directly after usage and only keep in well-ventilated rooms.
- Keep away from naked flames and electrical sparks in the charging area, as a highly-explosive gas mixture can be produced when charging batteries.
- Always keep batteries clean and dry to avoid leakage currents. Never short circuit the battery terminals.
- To avoid damage to health, smoking, eating and drinking in the area of the battery charging station is to be avoided.
- The battery must only be charged with the front panel open and secured by the cover holder.
- Ensure safe and environmentally-friendly disposal of operating and auxiliary materials, as well as replacement parts, particularly batteries!



SAFETY INSTRUCTIONS FOR CARE AND MAINTENANCE

- Before cleaning and maintaining the equipment, replacing parts or changing to a different function, the equipment is to be switched off.
- Spare parts must correspond to the requirements laid down by the manufacturer. This is always guaranteed for original spare parts.
- Accessories and spare parts must only be installed by an authorised customer service department.
- For work on the electrical system, the battery is to be disconnected.
- The equipment must not be cleaned with a hosepipe or high-pressure water jet (risk of short-circuits or other damage).
- Repairs must only be made by the permitted customer service centres or by experts in this field familiar with all the relevant safety regulations.
- Follow the safety review according to the locally-applicable regulations for mobile industrial equipment.
- Always wear suitable gloves when working on the equipment.

SYMBOLS IN THE OPERATING MANUAL

| | |
|---|---|
|  | WARNING! CAUTION! DANGER! THE INSTRUCTIONS DESCRIBED MUST BE FOLLOWED |
|  | WEAR BREATHING PROTECTION! |
|  | WEAR PROTECTIVE GOGGLES! |
|  | WEAR GLOVES! |

SYMBOLS ON THE SWEEPER

| | |
|---|--|
|  | WARNING! CAUTION! DANGER! THE INSTRUCTIONS DESCRIBED MUST BE FOLLOWED! |
|  | FOLLOW THE OPERATING INSTRUCTIONS! |

SAFETY EQUIPMENT

- Safety equipment is to be inspected for functioning before starting work.
- Only allow the sweeper to be switched on if the following conditions are met:
 - a) The power button is in the ON position.
 - b) The equipment panel is closed

The sweeper is interrupted when:

- a) The power button switched to the OFF position
- b) The equipment panel is open

The safety equipment attached to the machine must not be bypassed or put out of operation.

SHUTDOWN / RECYCLING

After the useful life of the machine is over, it must be disposed of expertly. However, individual parts may be thoroughly reused.

For the disposal of all equipment parts, the disposal conditions specific for the location are applicable.

INSTRUCTION Please ask your supplier about disposal of the equipment.

WASTE DISPOSAL / RECYCLING

Recycling packaging materials. Do not dispose of packaging materials in normal waste but forward for reprocessing.

For the disposal of all packaging materials, the disposal conditions specific for the location are applicable.

CONTROL PANEL LED CODE GUIDE

| LED CODE | REASON / FAULT | SOLUTION |
|--|---|--|
| One sweeping mode LED is solid | Normal operating condition | No action required |
| One sweeping mode LED is flashing fast | Motor overload has shut down machine due to obstruction. | Disconnect battery cable and check main brush, side brush and fan. Remove obstruction. Reset circuit breaker button. |
| One sweeping mode LED is flashing slowly and battery discharge indicator is flashing | Low battery level. | Recharge battery. |
| All sweeping mode LED's are flashing fast | Machine cover is open. The safety switch has shut down machine. | Close machine cover. |
| | Machine is in charging mode. Battery charger is plugged into electrical outlet. | No action required or unplug battery charger. |
| | Defective battery. | Replace battery. |
| | Machine cover lock-down knob is loose. | Check lock-down knob to ensure knob is tight and machine cover is secure. |
| | Defective, misaligned or loose machine cover safety switch. | Check, adjust or replace switch. |
| | Defective motor(s) or loose electrical connection to motor. | Disconnect battery cable and check all motors for proper operation. Reset circuit breaker button. |
| | Loose or damaged electrical connection. | Disconnect battery cable and check electrical harness for loose or damaged wire connections. |
| | Main brush and side brush not properly adjusted. | Readjust main and/or brush height. Reset circuit breaker button. |
| | Motor overload, excessive belt tension. | Check belt tension for proper adjustment, replace belt if worn. Reset circuit breaker button. |
| Worn or damaged main brushes. | Replace main brushes. | |

Control Panel



Sweeping Mode LED's (Fault Codes)

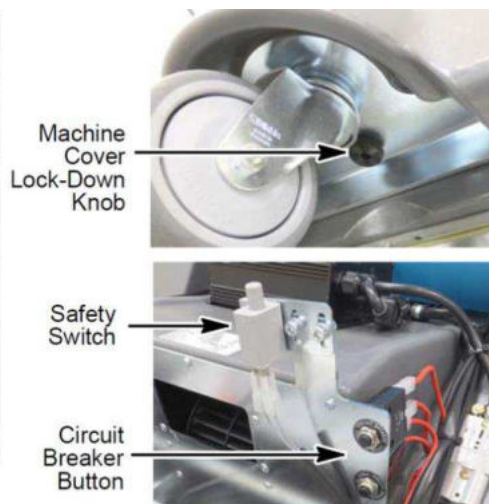

TROUBLESHOOTING

| Help for faults | | |
|----------------------------------|--|---|
| Fault | Possible cause | Remedy |
| Device does not start | Battery state $\leq 20\%$ | Charge battery |
| | Battery cable not correctly connected or loose | Check cabling of the batteries and connect correctly |
| | Safety switch equipment panel not operated | Close equipment panel correctly. |
| | Overload or fault with the main relay | Check and replace main relay |
| | Cause unclear | Notify your dealer or customer services |
| Roller brushes are not running | Straps, large packaging residues etc. have been swept up | Turn key switch to "0" (switch off sweeper). Check roller brushes for jammed or picked-up objects such as, for example, straps, cables etc., remove them and check the drums for damage and free running. |
| | Functional fault of the toothed belt or gear wheels (e.g. toothed belt has come off) | Check toothed belt and gear wheels |
| | Roller brush motor overloaded (check brushes for free running, as appropriate) | Check and replace relay of the roller brush motor |
| | Cause unclear | Notify your dealer or customer services |
| Bad sweeping in the edge region | Side brushes worn | Check for wear, readjust as required or replace the side brushes |
| | Side brushes have not lowered | Lower the side brushes |
| | Functioning of the side sealing rubber restricted by wear, a fault or similar. | Replace side sealing rubbers as appropriate |
| | Cause unclear | Notify your dealer or customer services |
| Sweeper does not sweep correctly | Roller brushes or sweeping tunnel blocked by sweeping material | Check sweeping tunnel for contamination or blockages and remove them |
| | Roller brushes or side brushes worn or not set correctly | Check roller brushes and side brushes for wear, readjust or replace as required |
| | Sealing rubber damaged by foreign bodies or running over obstacles without a ramp | Check front, side and rear sealing rubber for damage and correct seating and replace as necessary |
| | Roller Brushes are not installed according to their direction of rotation | Remove roller brushes and fit according to the direction of rotation |
| | Cause unclear | Notify your dealer or customer services |
| Device raises dust | Dust filter no longer cleaned | Check, clean or replace dust filter |
| | Sealing rubber faulty, so that the vacuuming system cannot work properly | Check front, side and rear sealing rubber for damage and correct seating |
| | Dirt-hopper is full | Empty dirt-hopper. |
| | Sealing section fastened wrongly or faulty | Check sealing section on the filter cover and replace as |
| | Sweeping tunnel blocked by bulky sweeping material so that no sweeping material can be transported into the dirt-hopper any longer | Remove contaminations or blockages in the sweeping tunnel |
| | Cause unclear | Notify your dealer or customer services |
| Electrical fault | Overload or wear of electrical components or cause unclear | Notify your dealer or customer services |

See **CONTACT DATA**, page 10

MAINTENANCE WORK / MAINTENANCE TABLE

i **Instruction:** The following maintenance work must be carried out by instructed and authorised specialist staff at the set intervals.



CAUTION! In the event that damage to the machine is established, it must not be used until the damage has been remedied by specialist staff.

⚠ RISK! → Risk of Injury The motor(s) need(s) to overrun for several seconds after being shut off.
→ In this time, you must keep clear of the drive area.

⚠ CAUTION!

- Allow the equipment to cool down sufficiently before all maintenance and repair work
- Unplug the charger from the socket.
- Disconnect the plus terminal from the battery.

TIPPING THE SWEEPER, SEITE 18

| Activity | Interval | | | |
|--|----------|--------|----------------|------------------|
| | Daily | Weekly | Every 50 hours | |
| Check machine for damage and functional faults and remedy as appropriate. | • | | | |
| Check the battery charge; charge batteries as appropriate. | • | | | (13), 16,17 |
| Empty the refuse container | • | | | 20 |
| Check sweeping roller & sweeping roller housing for damage, for foreign bodies and for wear; remove any foreign bodies/ clean or replace the sweeping roller | • | | | 14,15 (18),19 |
| Check side brushes for foreign bodies, straps etc.; remove/clean as appropriate. | • | | | 21 |
| Check side brush setting; readjust or replace side brushes as appropriate | • | | | |
| Check the condition of the dust filter; clean as appropriate | • | | | |
| Check the charge of the batteries before each usage | • | | | 13,16, 17 |
| Undertake all daily maintenance work | | • | | |
| Check the sealing rubber in the sweeping roller area for wear and damage; replace as appropriate | | • | | |
| Check dust filter for damage; replace as appropriate | | • | | |
| Functional test of the entire machine | | • | | |
| Check all toothed belts for tension, wear and operation; replace as appropriate | | • | | |
| Check the Bowden cables and all moving parts for their smooth running; replace as appropriate | | • | | |
| Check the Bowden cables for extension of the pull cable | | • | | |
| Check safety components (end switch filter cover) | | • | | |
| Conduct all daily and weekly maintenance work | | | • | |
| Check battery condition; replace as appropriate | | | • | 13,16, 17 |
| Check smooth running of the wheels (replace any bearings) | | | • | |
| Check all bearings for damage | | | • | |
| Check all screws and fastenings | | | • | |
| Check all covers and steel parts for firm seating | | | • | |
| Check the operation of the charger | | | • | |

SHUTDOWN, DISMANTLING, DISPOSAL

LONG-TERM STOPPAGE OF THE SWEEPER

• INSTRUCTION!

If it is stopped for a long period, the batteries must charge at intervals of approximately 2 months so they are not damaged by a deep discharge.

- Set down the sweeper onto a level, dry and protected surface.
- Switch the power button into the "OFF" position and pull out.
- Secure sweeper against rolling away.
- Raise sweeping roller. To do this, adjust the level to the lowest position and stop.
- Raise the side brushes.
- Clean the dust filter.
- Empty the refuse container.
- Clean the sweeper inside and out.
- Disconnect the battery.

SHUTDOWN / RECYCLING



After the useful life of the machine is over, it must be disposed of expertly. However, individual parts may be thoroughly reused.

For the disposal of all equipment parts, the disposal conditions specific for the location are applicable.

INSTRUCTION Please ask your supplier about disposal of the equipment.

WASTE DISPOSAL / RECYCLING



Recycling packaging materials. Do not dispose of packaging materials in normal waste but forward for reprocessing.

For the disposal of all packaging materials, the disposal conditions specific for the location are applicable.

IMPORTANT SPARE PARTS AND CONSUMABLES

| | |
|--------------------------|-----------------|
| Flat filter | Item No. 101576 |
| Sweeping Roller PA 0.25V | Item No. 110501 |
| Side Brushes PA 0.6 | Item No. 110164 |

CONTACT DATA

**Manufacturer: Stolzenberg GmbH &
Co. KG Hamburger Straße
15-17 49124
Georgsmarienhütte
T: +49 (0) 5401 / 8353-0
F: +49 (0) 5401 / 8353 - 11
E: service@stolzenberg.de**

Dealer:

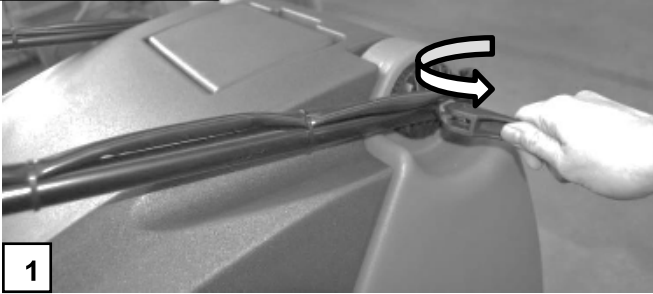
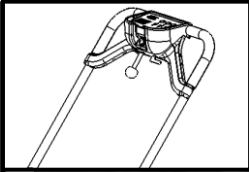
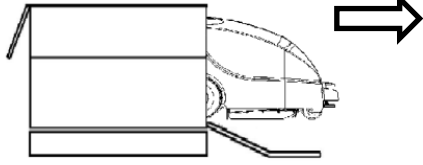

1

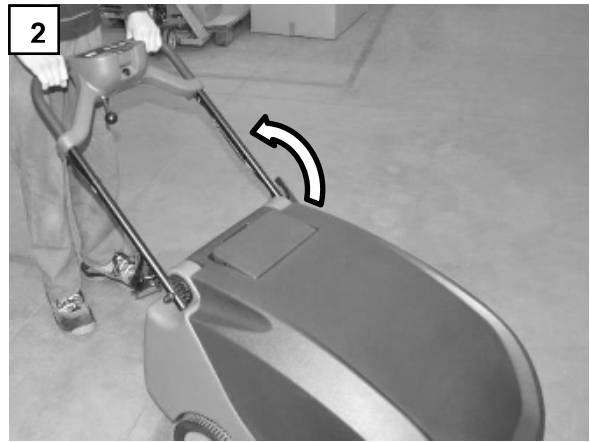

2

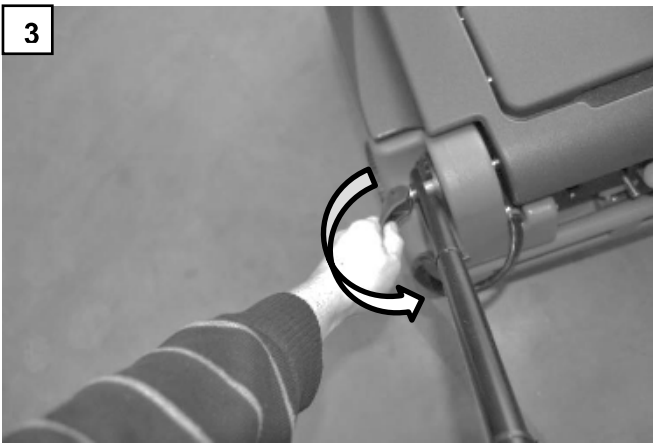

3

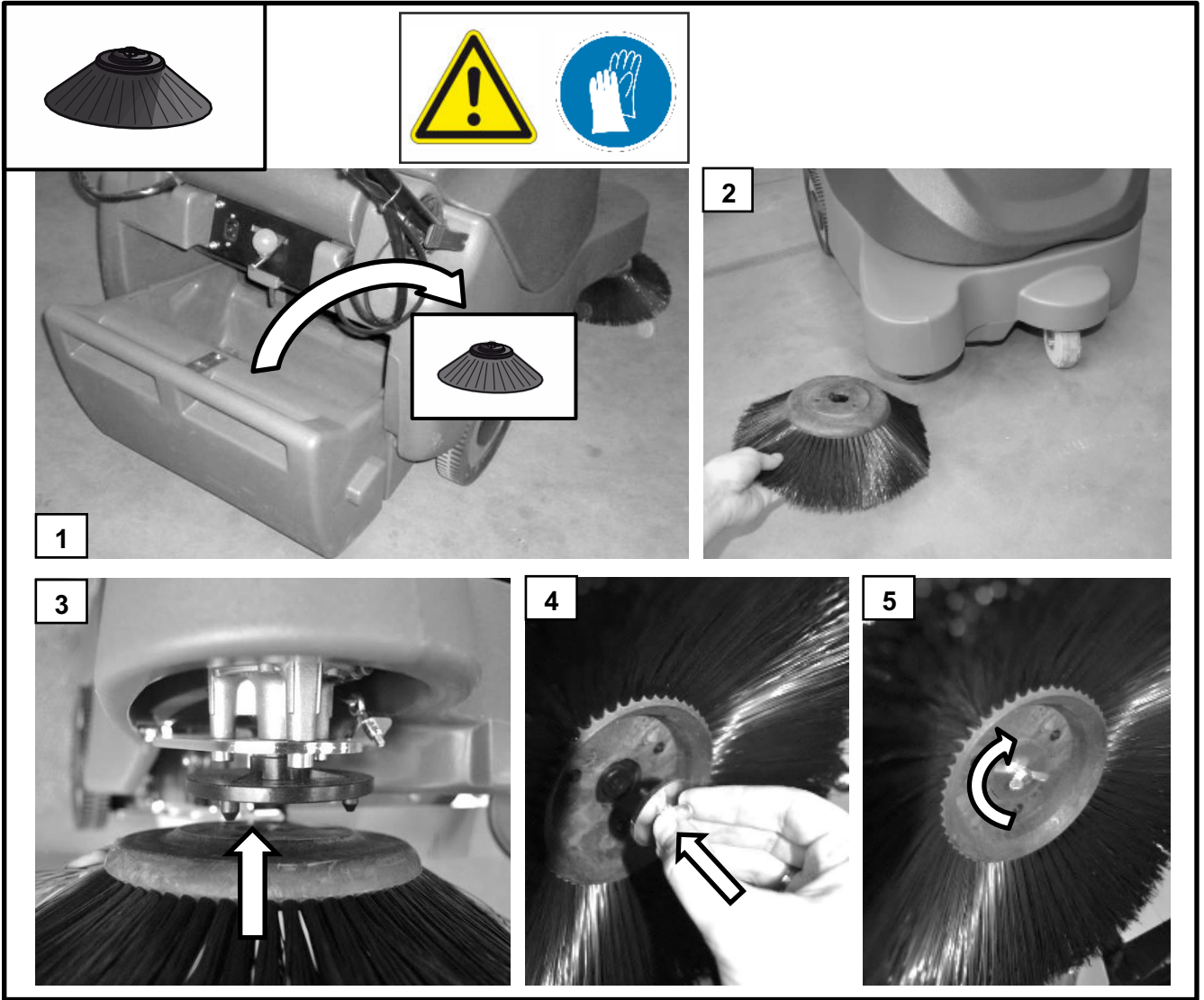

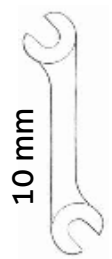
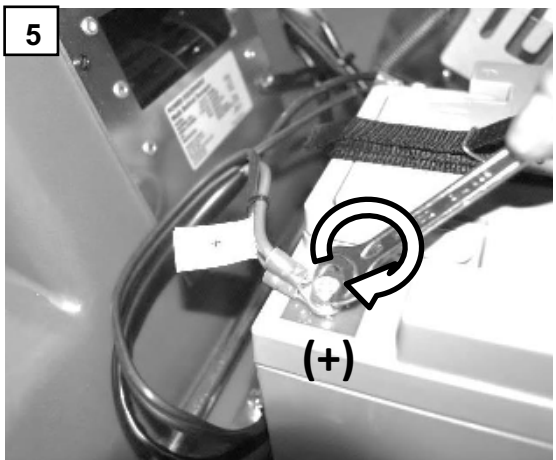
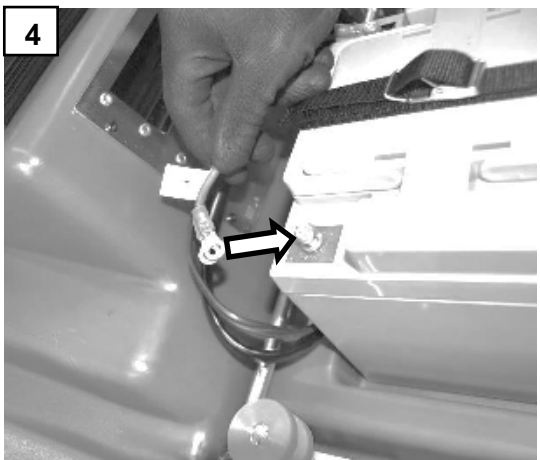
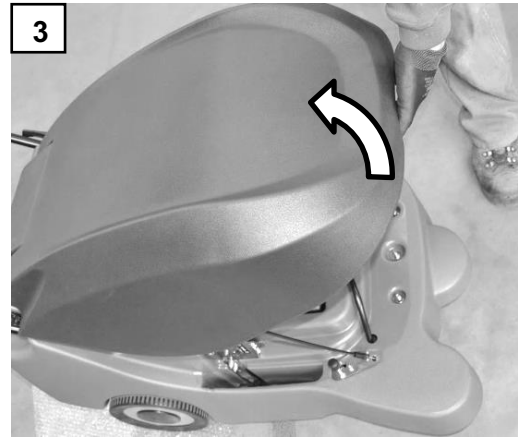
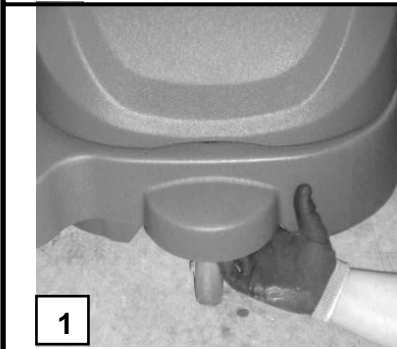
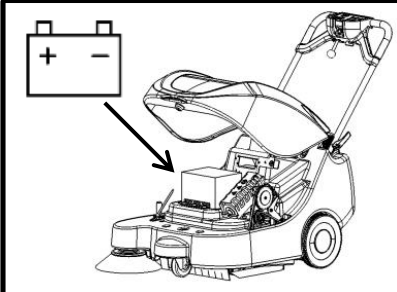

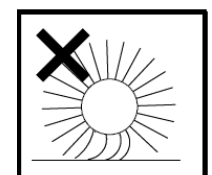
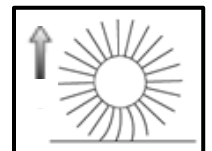
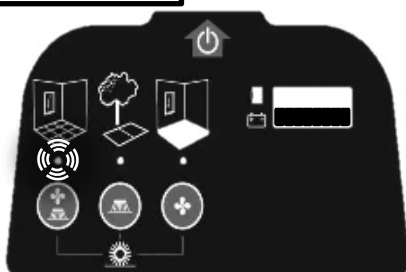
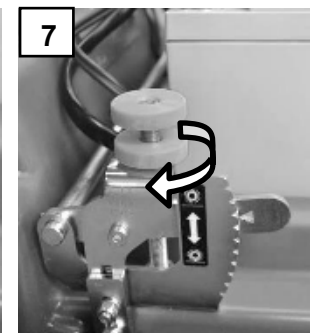
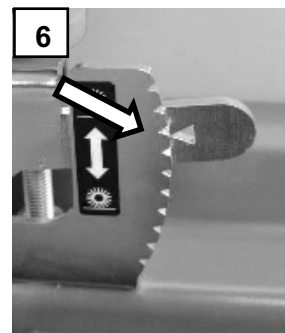
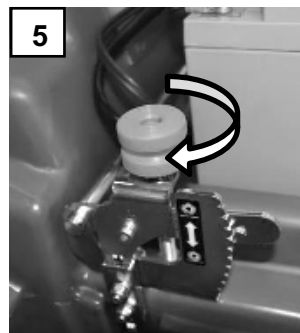
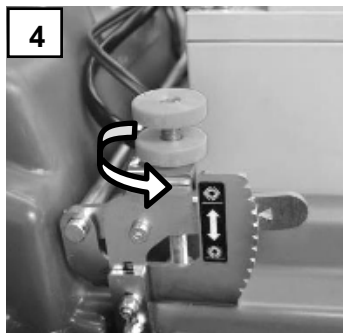
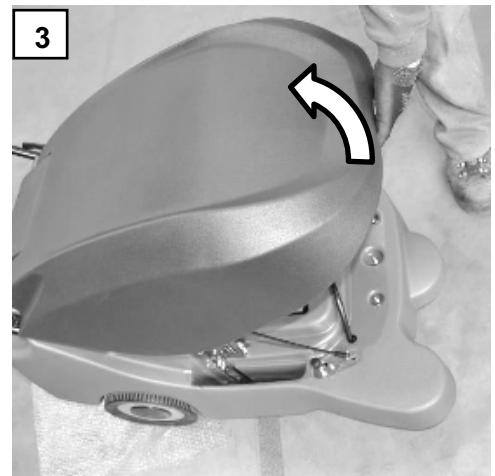
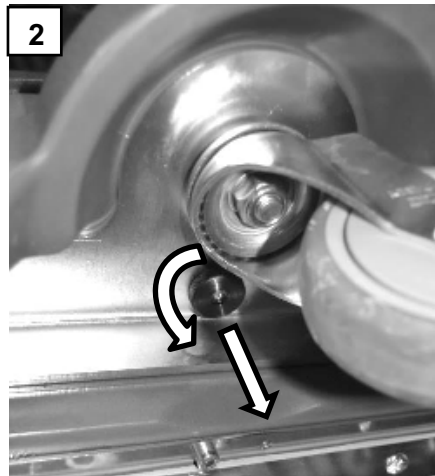
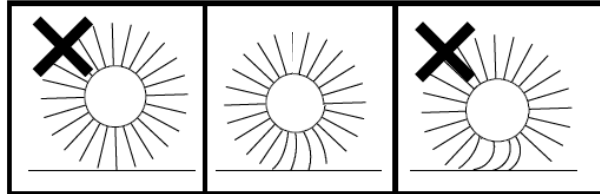
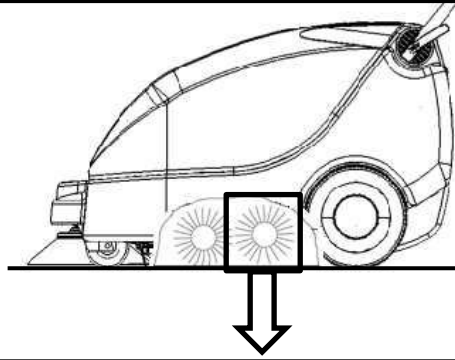
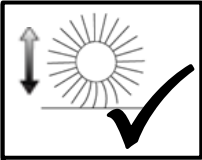

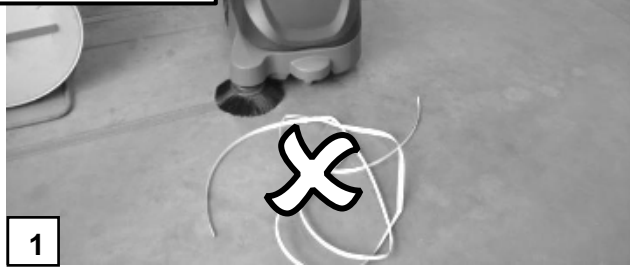
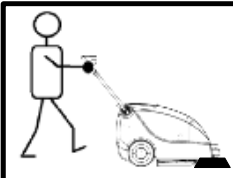

1

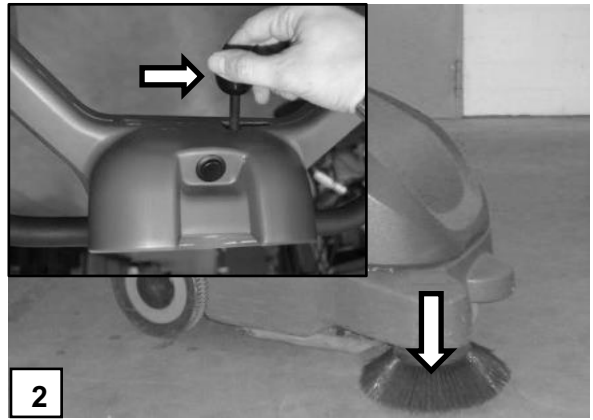

2



3

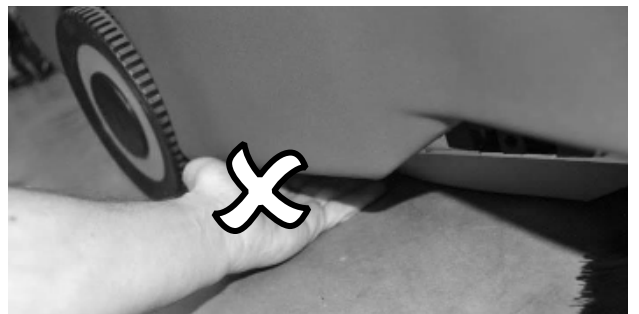
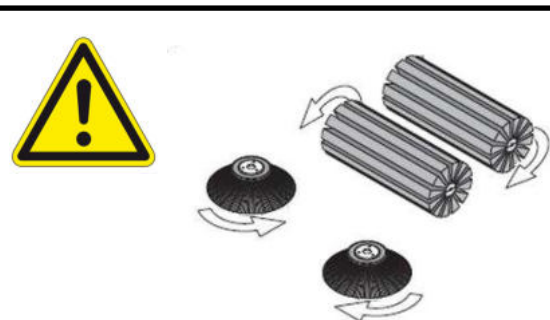
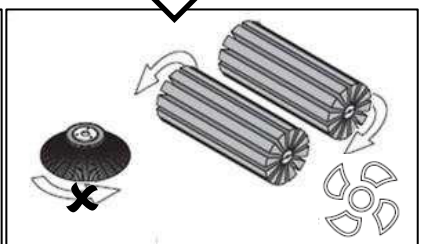
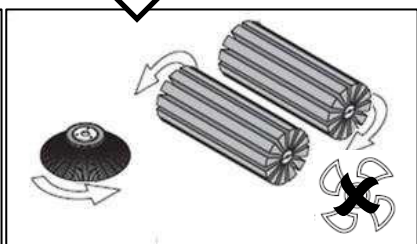
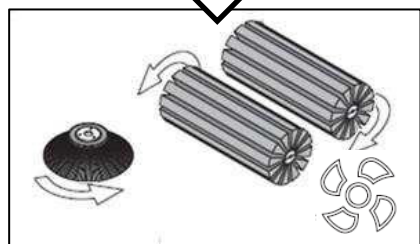

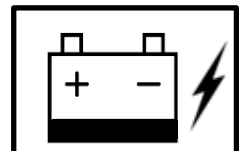
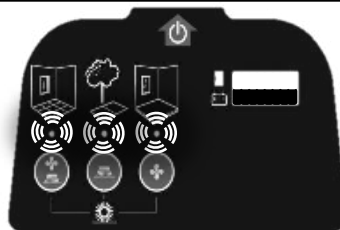
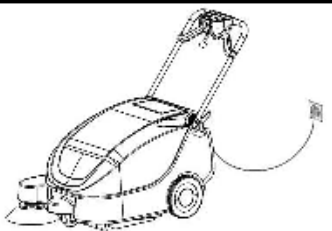
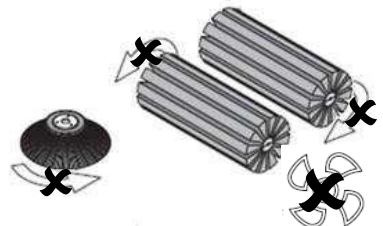
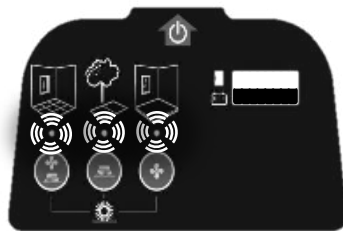
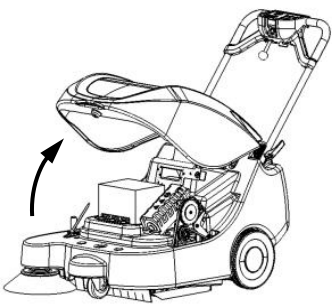
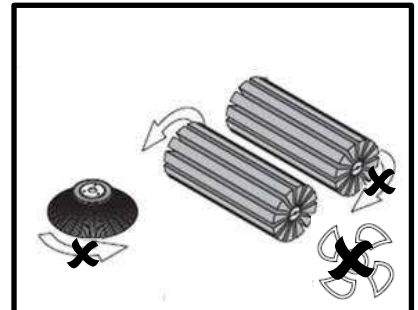
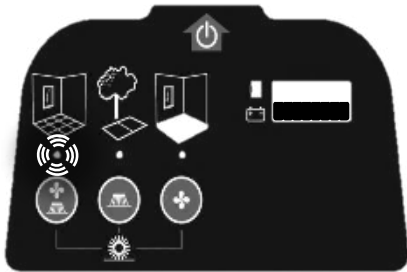
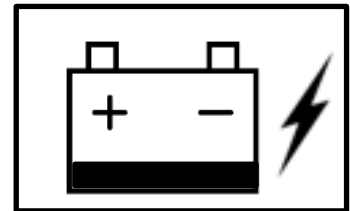
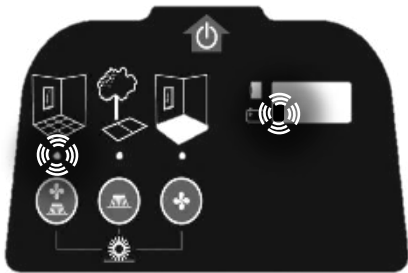
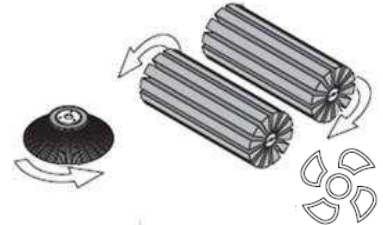
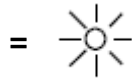
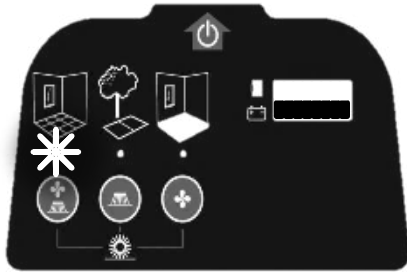

BEDIENFELD LED-CODEFÜHRUNG - Siehe Seite 7
CONTROL PANEL LED CODE GUIDE - See Page 15

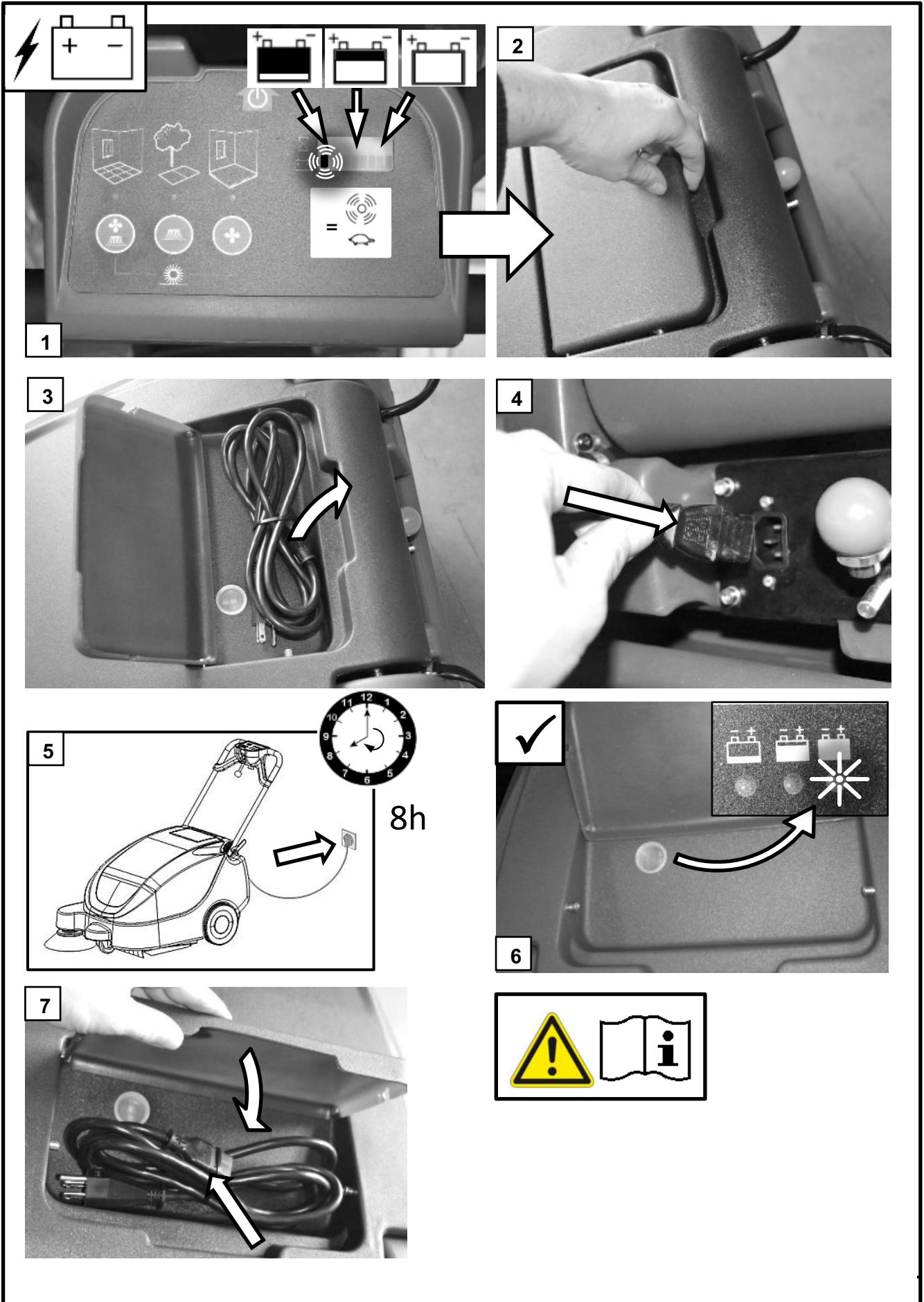

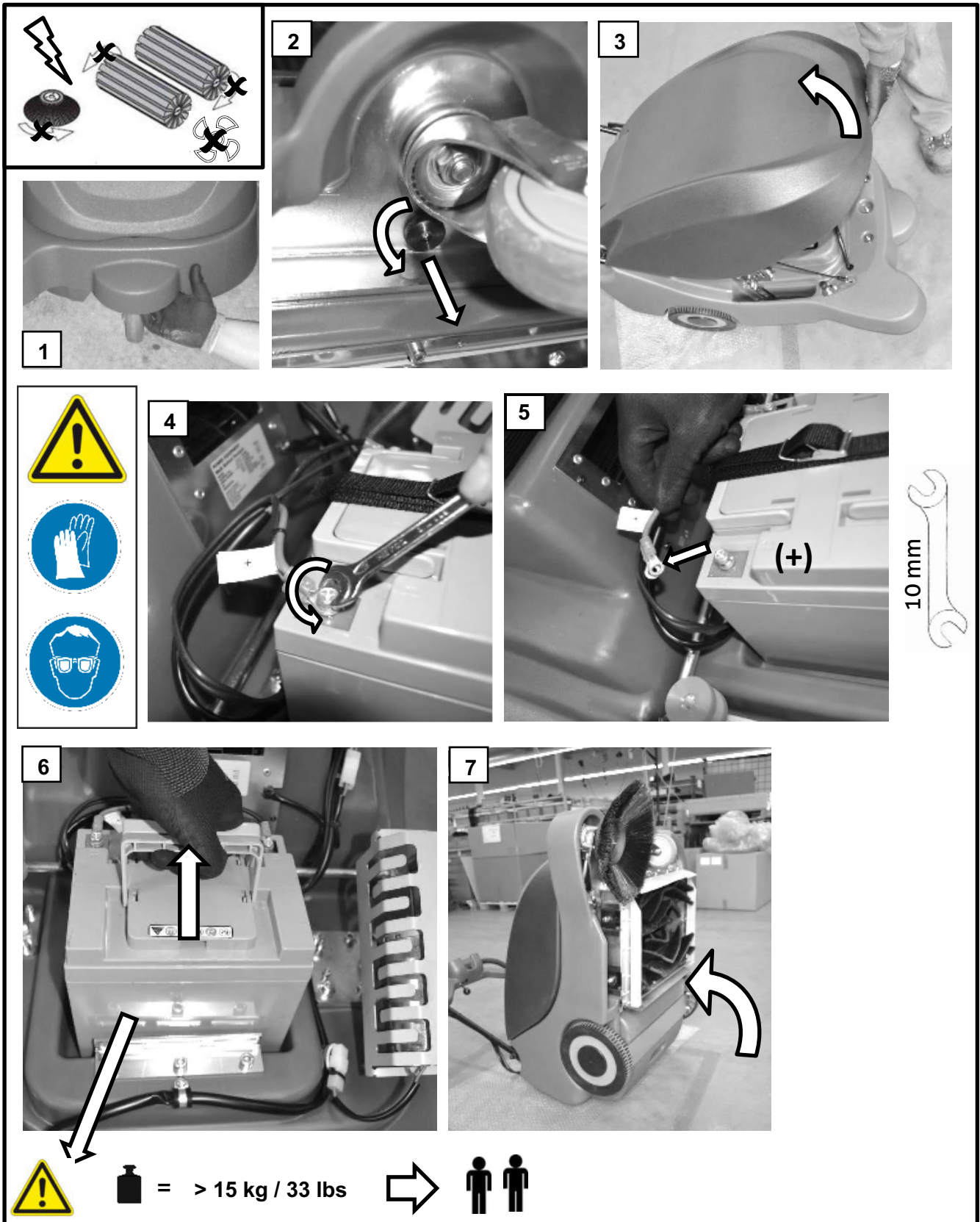

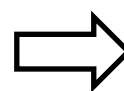
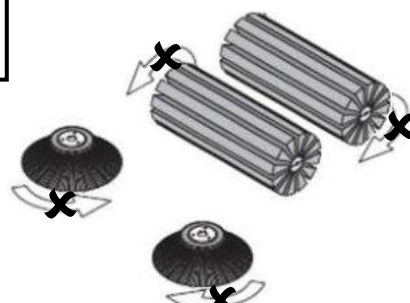
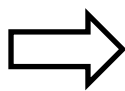
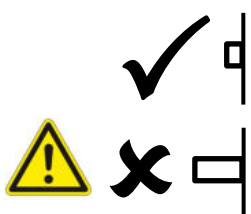
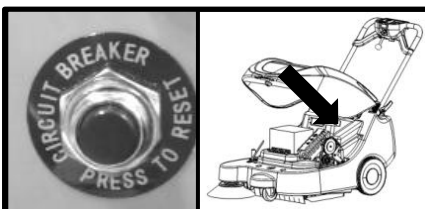
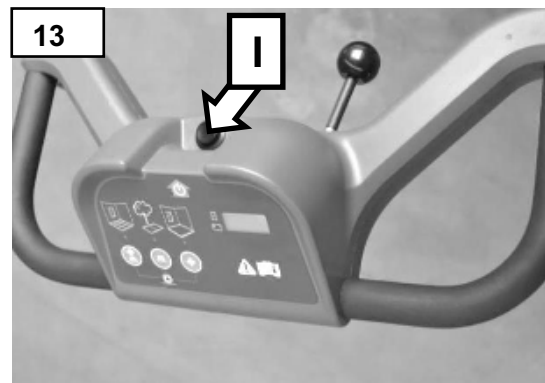
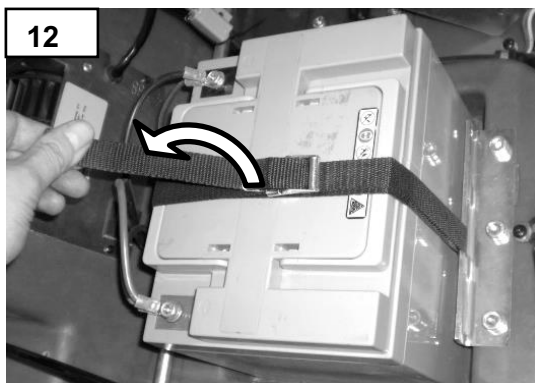
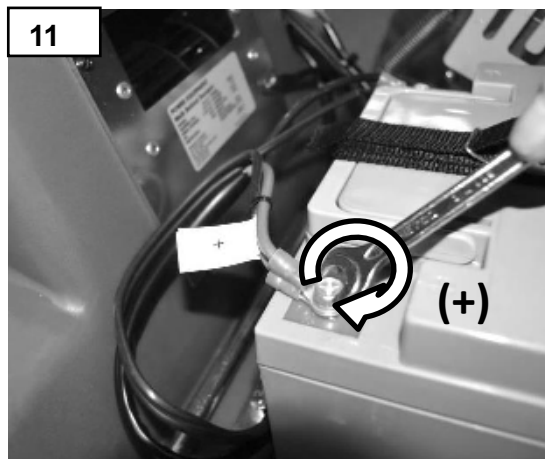
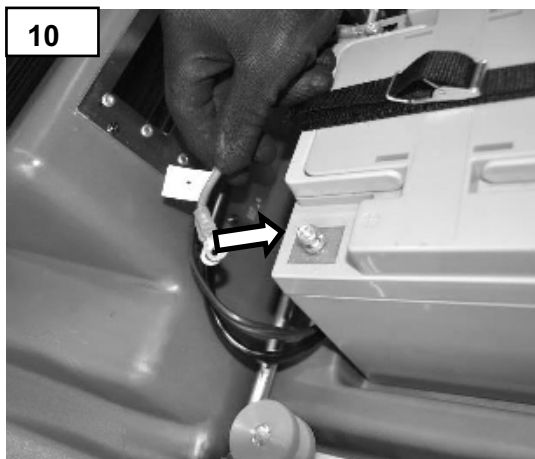
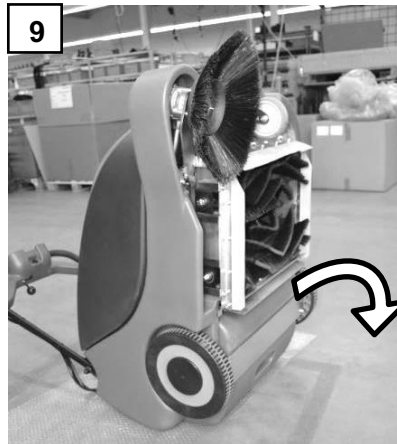
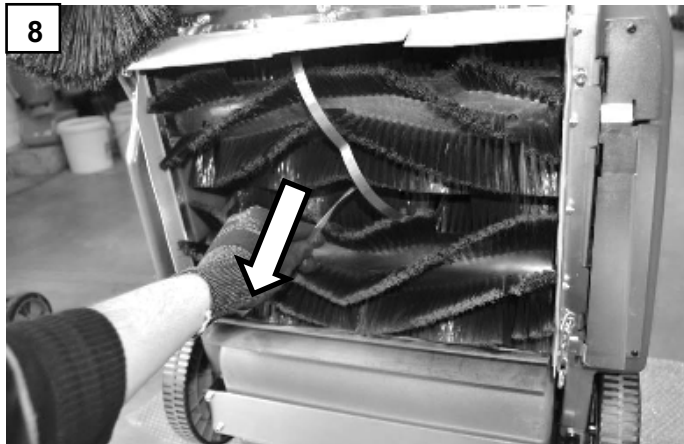

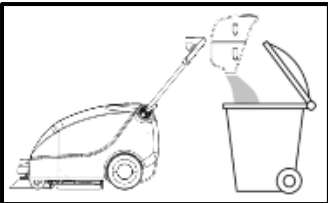

1



2

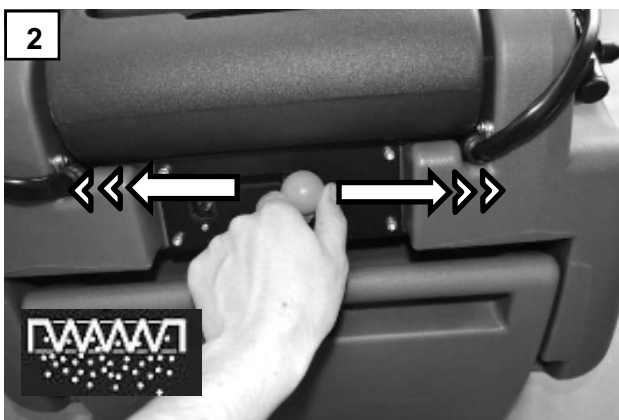

3





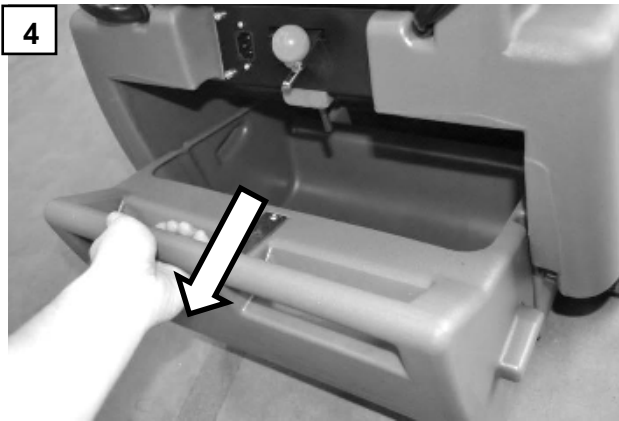

4



5



  = > 15 kg / 33 lbs  



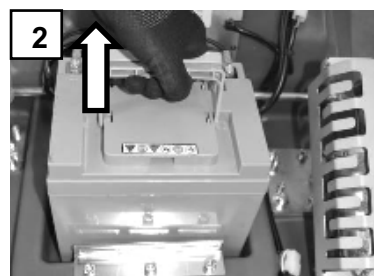
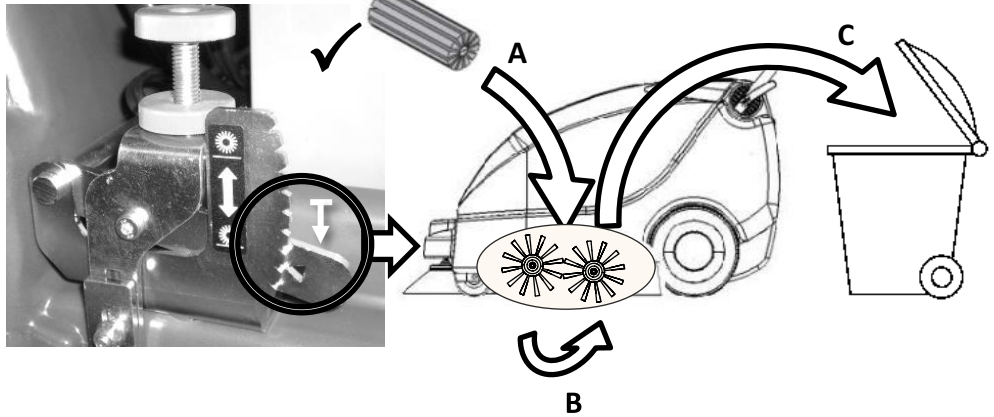

= > 15 kg / 33 lbs

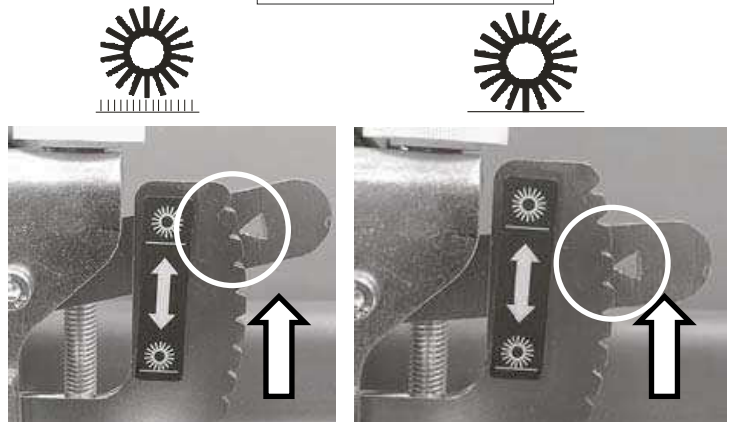
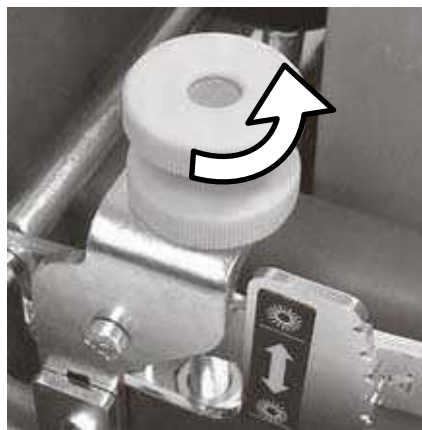
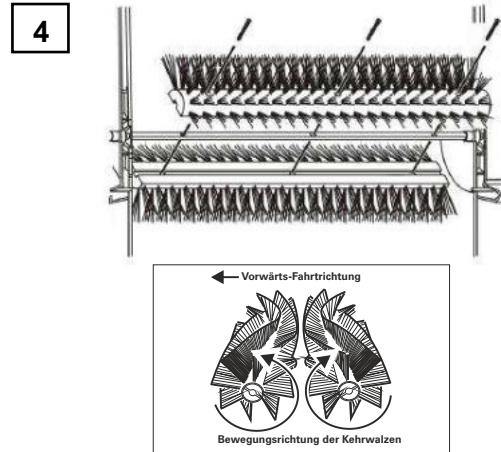

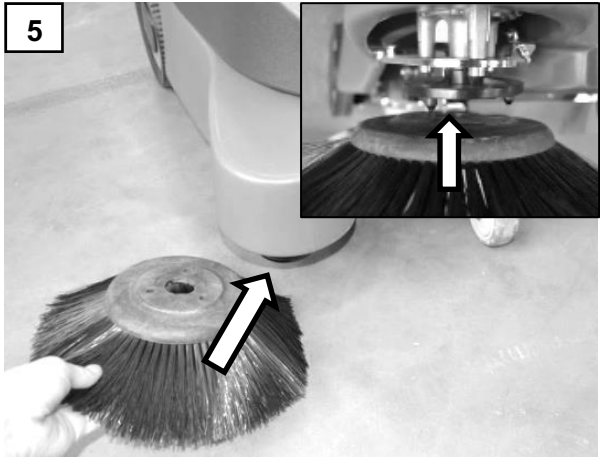
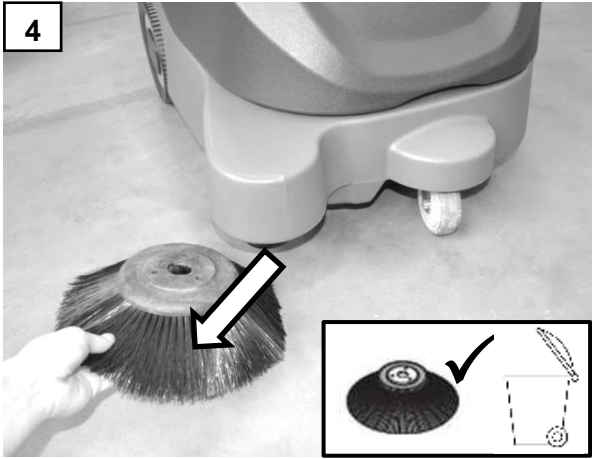
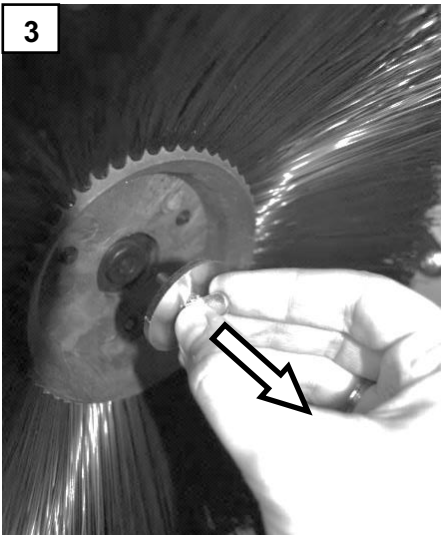
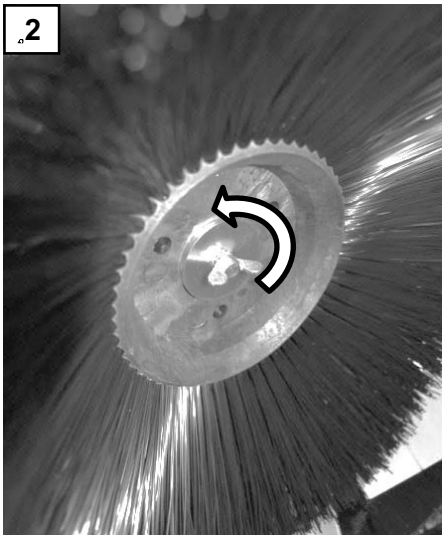
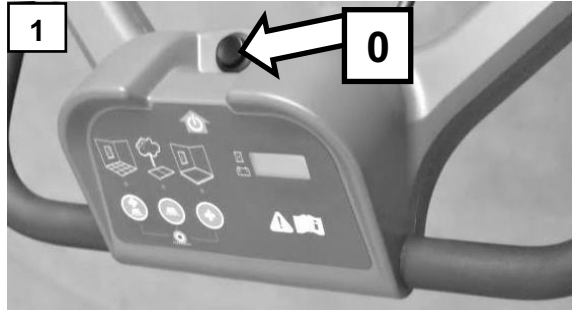

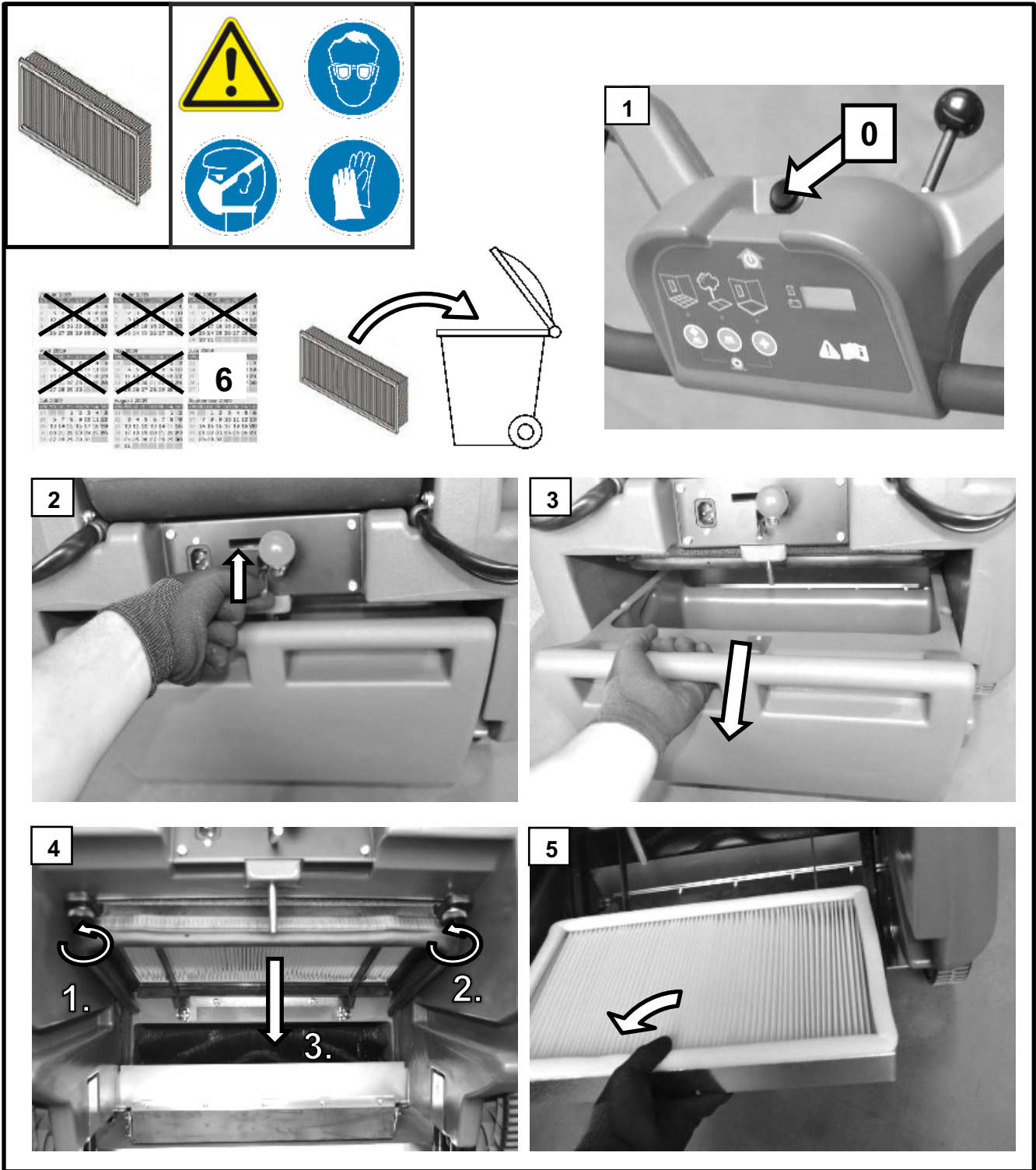

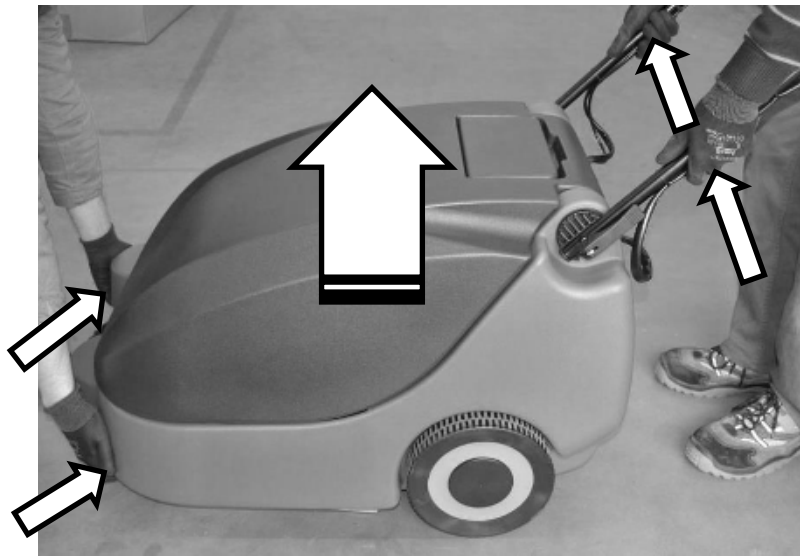
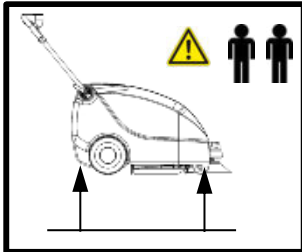
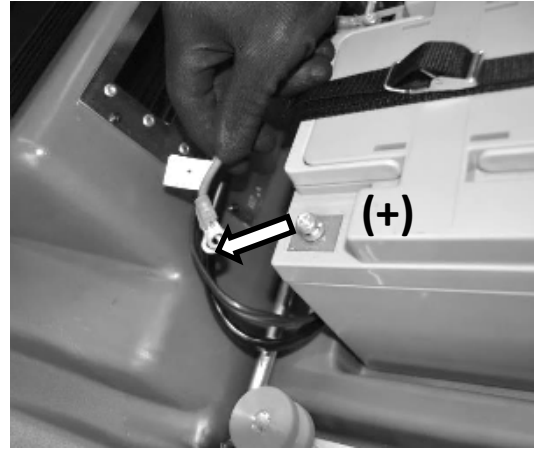
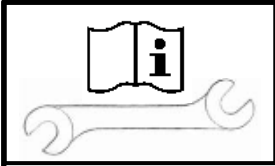

ELECTRICAL DIAGRAM

